

University of Leoben

**Monitoring Process Parameters  
affecting the Triboelectrostatic Separation  
of Industrial Minerals**

**Graduation Thesis**

in partial fulfillment of the requirements for the degree of  
Diplomingenieur (Dipl.-Ing.)

submitted to the

**Department of Mineral Resources and Petroleum Engineering  
Chair of Mineral Processing**

Head: Univ.-Prof. Dipl.-Ing. Dr. mont. Helmut Flachberger

cand.ing. Matthias Reisinger  
Mauthausener Straße 46  
4040 Linz  
Matr.Nr.: 0055946

Leoben, Jänner 2007

## **STATUTORY DECLARATION**

I herewith declare, in lieu of an oath, that I have developed and written the enclosed graduation thesis entirely by myself and have not used sources or means without declaration in the text. All quotations and statements which were inferred literally or in a general manner from these sources are clearly marked as such. This thesis has not been submitted in the same or in a substantially similar version, not even partially, to any other authority to achieve an academic grading and was not published elsewhere.

## **EIDESSTATTLICHE ERKLÄRUNG**

Ich erkläre an Eides statt, dass ich die vorliegende Arbeit selbständig und ohne fremde Hilfe verfasst, andere als die angegebenen Quellen nicht benützt und die den benutzten Quellen wörtlich oder inhaltlich entnommenen Stellen als solche kenntlich gemacht habe.

Leoben, 24. Jänner 2007

Matthias Reisinger

## **ABSTRACT**

Due to progressive depletion of high-grade deposits, the dry beneficiation of calcium carbonate raw material by triboelectric means is becoming increasingly attractive. The present paper gives a review of the main aspects of tribocharging and the subsequent behaviour of the charged particles in the electric field of a free-fall separator. Particular emphasis is devoted to the extent of influence of material properties and equipment characteristics on electrostatic separation.

The investigation aimed at evaluating the optimum design criteria for the development of a commercial electrostatic separator to successfully remove siliceous and colouring constituents from calcium carbonate. Therefore, a pilot-scale electrostatic separation system with a nominal capacity of 2.7t/h was developed. The experimental procedure and the instrumentation used in the study are described in detail.

Under proper conditions, mineral particles acquire selectively electrical charges according to the differences in their energetic surface structures, and can be separated when passed through the plate-type separator. The experimental data exhibit that the best separation results are obtained when the mineral sample is heated above 80°C and processed in dry atmosphere. Other parameters that strongly influence the efficiency of separation are splitter position, feed rate and fineness of the feed material. Magnitude and polarity of the imparted charges may also be altered by modifying temperature and/or material of the tribocharger.

Despite the research is far from being concluded, the prospects for the industrial application of triboelectric separation in dry processing of calcium carbonate are fruitful.

## **KEYWORDS**

Electrostatic separation; Tribocharging; Free-fall separator; Material properties; Equipment characteristics; Calcium carbonate.

## **ZUSAMMENFASSUNG**

Die Verwendung mineralischer Rohstoffe als hochwertige Füllstoffe in der Papier-, Farben-, Lack- und Kunststoffindustrie bedingt die Einhaltung höchster Qualitätsanforderungen. Elektrostatische Sortierung im Freifallscheider nach erfolgter Triboaufladung bietet die Möglichkeit einer trockenen Abreicherung des bergmännisch hereingewonnenen Calciumkarbonats an Begleit- und Schadstoffmineralen. Die vorliegende Arbeit gibt einen Überblick über die wesentlichen Aspekte der triboelektrischen Aufladung sowie der nachfolgenden Trennung im elektrischen Feld. Besondere Aufmerksamkeit gilt der Beeinflussung des Sortierergebnisses durch gezielte Änderung der Prozessparameter.

Für die Sortierung von entstaubten Prozessströmen wurde ein Prototyp mit induzierter triboelektrischer Partikelaufladung und einer Durchsatzleistung von 2.7t/h entwickelt. Der apparative Aufbau sowie die Methodik der Versuchsdurchführung werden im Detail beschrieben.

Unter geeigneten Prozessbedingungen wurden an den Mineraloberflächen selektiv unterschiedliche elektrische Ladungen induziert, welche eine Trennung im elektrostatischen Feld des Freifallscheiders ermöglichten. Die Versuchsergebnisse belegen, dass Guttemperatur und –dispersität sowie die relative Feuchtigkeit der Umgebungsluft bestimmenden Einfluss auf das Trennergebnis besitzen. Erhöhte Rohguttemperaturen, niedrige Luftfeuchten und Begrenzung des Über- und Unterkornanteils beeinflussen den Prozess im positiven Sinne. Höhe und Polarität der durch Triboelektrifizierung aufgebrachtene elektrische Ladung können weiters durch Temperatur und Werkstoff des Kontaktpartners verändert werden. Die Erzielung befriedigender Sortierergebnisse setzt eine Beschränkung des Durchsatzes sowie eine Abstimmung der Trennschneidenstellung voraus.

Die im Rahmen der vorliegenden Arbeit erzielten Ergebnisse ermöglichen die Abschätzung des Einsatzes der triboelektrischen Sortierung von calciumkarbonatischem Rohgut unter variablen Bedingungen und dienen als Basisdaten für die Auslegung einer großtechnischen Anlage.

## **SCHLAGWÖRTER**

Elektrostatiksecheidung; Triboaufladung; Freifallscheider; Elektrische Eigenschaften der Stoffe; Prozessparameter; Calciumkarbonat.

# TABLE OF CONTENTS

<b>LIST OF FIGURES</b> .....	<b>III</b>
<b>LIST OF TABLES</b> .....	<b>V</b>
<b>1. INTRODUCTION</b> .....	<b>1</b>
1.1. Objective Target .....	1
<b>2. THEORY OF ELECTROSTATIC SEPARATION</b> .....	<b>2</b>
2.1. Fundamentals of Electrical Conduction.....	3
2.2. Mechanism of Charge Transfer .....	4
2.3. Triboelectrostatic Separators .....	6
2.3.1. Competing Forces .....	6
2.3.2. Tribocharging Devices and Media .....	9
2.4. Factors affecting Triboelectrostatic Separation Process.....	10
2.4.1. Material Properties .....	10
2.4.2. Equipment Characteristics.....	15
<b>3. TEST MATERIAL CHARACTERISATION</b> .....	<b>17</b>
3.1. Mineralogy.....	17
3.2. Chemical Composition .....	19
3.3. Particle Size .....	20
3.4. Liberation.....	22
3.5. Electrical Properties of Minerals .....	22
<b>4. EXPERIMENTAL APPARATUS AND PROCEDURE</b> .....	<b>23</b>
4.1. Triboelectrostatic Separation System .....	23
4.2. Experimental Procedure.....	25
4.2.1. Prearrangements .....	25
4.2.2. Electrostatic Separation Testing.....	25
<b>5. RESULTS OF SEPARATION TESTS</b> .....	<b>28</b>
5.1. Pre-Tests .....	28
5.2. Parameter Test Series .....	28
5.2.1. Splitter Position .....	29

---

5.2.2. Feed Rate.....	30
5.2.3. Feed Temperature.....	33
5.2.4. Ambient Humidity.....	35
5.2.5. Feed Moisture.....	39
5.2.6. Fines Content.....	39
5.2.7. Vibratory Feeder Temperature.....	40
5.3. Multistage Separation.....	42
5.4. Extensive Analysis of Separation Products.....	44
5.4.1. Partition Numbers.....	44
5.4.2. Slurry Grinding.....	47
<b>6. OUTLOOK AND DISCUSSION.....</b>	<b>48</b>
<b>REFERENCES.....</b>	<b>50</b>
<b>APPENDIX.....</b>	<b>54</b>

## LIST OF FIGURES

Figure 2-1: Particle charging process.....	2
Figure 2-2: Electron energy band diagrams .....	3
Figure 2-3: Mechanism of charge transfer before (left) and after (right) contact.....	4
Figure 2-4: Schematic illustration of a triboelectrostatic separator .....	6
Figure 2-5: Resistivity as a function of temperature for some minerals.....	11
Figure 2-6: Dependence of force ratios on particle shape .....	13
Figure 3-1: Typical high-grade marble with mosaic structure (left) and coarse grained marble in contact to calc-silicate rock (right).....	17
Figure 3-2: Pyrite (left) and pyrrhotite (right) crystals under stereomicroscope.....	18
Figure 3-4: X-ray diffraction pattern of HCl-insoluble residue of marble sample.....	18
Figure 3-5: Particle size distribution of marble sample (log-log cumulative plot).....	20
Figure 3-6: Cumulated mass versus cumulated HCl-insolubles.....	21
Figure 4-1: Electrostatic separator: plate electrodes (left) and DC generators (right).....	23
Figure 4-2: Feed hopper and vibratory feeder (left) and precharging device (middle and right).....	24
Figure 4-3: Inner workings of the precharging shaft.....	24
Figure 4-4: Procedure of electrostatic separation tests.....	26
Figure 4-5: Denotation of separation products.....	26
Figure 5-1: Variation of splitter position.....	29
Figure 5-2: Insolubles grade and recovery in reject as a function of splitter position.....	29
Figure 5-3: Reject: Insolubles grade versus recovery .....	30
Figure 5-4: Insolubles grade of concentrate and reject as a function of carbonate loss .....	30
Figure 5-5: Mass recovery in electrostatic separation products as a function of feed rate .....	31
Figure 5-6: Insolubles grade and recovery in reject versus feed rate .....	32
Figure 5-7: Insolubles grade of concentrate and carbonate loss in reject versus feed rate .....	32
Figure 5-8: Mass recovery in separation products at different feed material temperatures using copper as shaft material .....	33
Figure 5-9: Mass recovery in separation products at different feed material temperatures using stainless steel as shaft material .....	34

---

Figure 5-10: Concentrate insolubles grade and carbonate loss versus feed temperature using copper as shaft material .....	34
Figure 5-11: Concentrate insolubles grade and carbonate loss versus feed temperature using stainless steel as shaft material .....	35
Figure 5-12: Insolubles grade and recovery in reject at different temperatures using copper and stainless steel as tribocharger material .....	35
Figure 5-13: Insolubles grade and recovery in reject versus ambient humidity .....	36
Figure 5-14: Concentrate insolubles grade and carbonate loss in reject versus ambient humidity .....	37
Figure 5-15: Schematic illustration of electrical resistance measurement device .....	37
Figure 5-16: Isolation conductance versus relative humidity.....	38
Figure 5-17: Calculated particle size distributions of prepared mixtures.....	39
Figure 5-18: Insolubles grade and recovery in reject versus fines content.....	40
Figure 5-19: Concentrate insolubles grade and carbonate loss in reject versus fines content .....	40
Figure 5-22: Insolubles grade and recovery in reject versus vibratory feeder temperature.....	41
Figure 5-23: Concentrate insolubles grade and carbonate loss in reject versus vibratory feeder temperature .....	41
Figure 5-24: Cumulative mass versus cumulative insolubles grade curve.....	42
Figure 5-25: Schematic flowsheet of 2-stage electrostatic separation.....	44
Figure 5-28: Partition numbers of electrostatic separation.....	45



## LIST OF TABLES

Table 3-1: Main mineralogical composition of the HCl-insoluble residue of marble sample.....	19
Table 3-2: Chemical analysis of marble sample by WDXRF .....	19
Table 3-3: Sieve analysis of marble sample.....	20
Table 3-4: Analysis of sieve fractions regarding HCl-insolubles.....	21
Table 3-5: Electro-physical properties of minerals present in marble sample .....	22
Table 5-1: 2-stage electrostatic separation results.....	43
Table 5-2: Analysis of separation performance by means of partition numbers .....	46
Table 5-3: Brightness and yellowness measurement of electrostatic separation concentrates .....	47

## **1. Introduction**

Today, ground calcium carbonate (chemical formula  $\text{CaCO}_3$ ) is the most widely used mineral additive for both paper and plastics industry in Europe. As multifunctional filler it has to meet the highest requirements regarding particle structure and size, degree of whiteness, abrasiveness, dispersibility and cost effectiveness.

Natural calcium carbonate is among the most widespread sedimentary rock forming minerals in the earth's crust. Although the deposits are plentiful, only a few provide raw material of sufficient high quality to allow application without requiring further beneficiation treatment.

Froth flotation following wet grinding has been established effectively to eliminate gangue minerals from the feed material. After an additional comminution stage, the final product is commonly delivered in slurry form at high solids content.

If dry products are requested, the concentrated slurry would have to undergo mechanical and thermal dewatering, being energetically and economically unfavourable. For that reason, the potential of electrostatic separation for the removal of interfering constituents from industrial minerals, favoured from calcium carbonate, in dry processing circuits is of particular interest.

### **1.1. Objective Target**

For the purpose of investigating operating parameters affecting the separation performance, a pilot-scale electrostatic free-fall separator with a capacity of 2.7t/h was developed. The aim of the present investigation is to evaluate its application at varying operating conditions for the beneficiation of calcium carbonate raw material, thereby acquiring the optimum design criteria for the development of a commercial, full-scale electrostatic separator.

## 2. Theory of Electrostatic Separation

Static electricity deals with the presence and interaction of temporarily fixed electrical charges.<sup>1</sup> Electrostatic separation is the sorting of solids by utilising forces acting on a charged or polarised particle when an external electrostatic field is applied.<sup>2</sup> The process is predominantly based on the selective development of electrical charges on the mineral surfaces in order to compel different trajectories in an electrical field.

Triboelectrification or frictional charging may happen at any dynamical contact of surfaces, e.g. sliding, rolling or vibration at a contact. Contact charging is based on the potential difference of two surfaces and does not implicitly involve relative mechanical motion between the contacting partners.<sup>3</sup>

When two dissimilar surfaces are intimately contacted, charge carriers can move across the boundary from one to another. When the contact is broken, they leave with the same magnitude of charge but opposite polarities (Figure 2-1). The amount of charge will be eliminated readily if the materials are good conductors, but some charge will remain on semi-conductors or insulators due to their considerable relaxation time.<sup>4</sup>

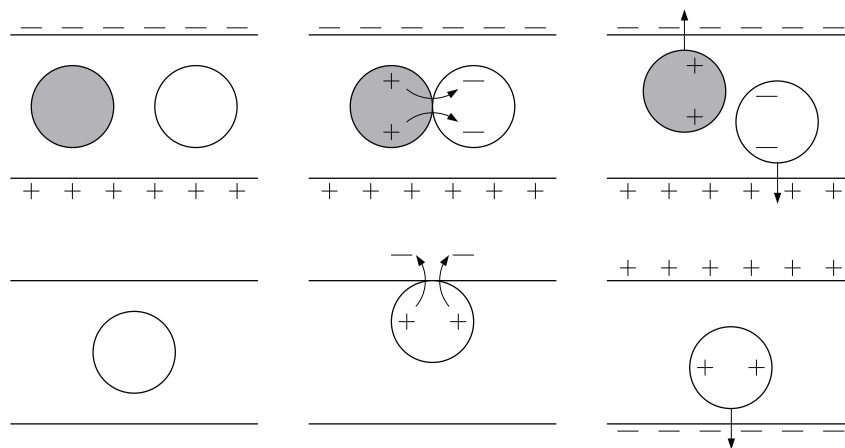

Figure 2-1: Particle charging process<sup>5</sup>

<sup>1</sup> Fraas, F., 1962, 3

<sup>2</sup> Manouchehri, H.R., 2000, 75

<sup>3</sup> Chang, J., A.J. Kelly and J.M. Crowley, 1995, 32-34

<sup>4</sup> Hendricks, C.D., 1973, 24-28

<sup>5</sup> Lee, J.-K. and J.-H. Shin, 2003, 572

Harper<sup>6</sup> mentions three primary ways in which charge can be transferred from one particle to another: electron transfer, ion transfer and material transfer. Electron transfer is generally believed to be the dominant mechanism for charge generation in triboelectrification, although there is evidence that ion and material effects contribute substantially in particular cases.

## 2.1. Fundamentals of Electrical Conduction

Electrical conduction is generally explained by means of the band theory. In the case of a free atom, electrons occupy atomic orbitals which build a discrete set of energy levels. As the isolated atoms move closer together to form a solid material, the available energy states interact to form continuous bands of energy which electrons may occupy, and forbidden gaps, which they may not. The existence of partly filled bands is vital for the electrical conduction. Bands that are completely full or empty of electrons cannot conduct electricity.<sup>7</sup>

According to their electronic band structure, solids can be divided into three classes: conductors, semiconductors and insulators (Figure 2-2). In the case of conductors, the valence band is only partly filled or valence and conduction bands overlap. Insulators are characterised by a full valence band and a large forbidden gap ( $\sim 10\text{eV}$ ). Hence, a thermal energy of an electric field is not sufficient to raise an electron from the valence to the conduction band. Semiconductors show a small energy gap ( $\sim 1\text{eV}$ ) between valence and conduction band so that thermal energy may allow electrons to pass into the conduction band.<sup>8</sup>

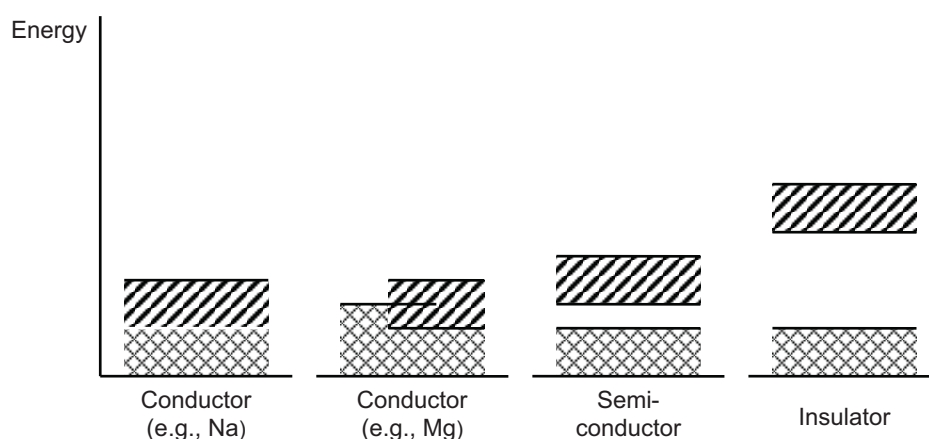

Figure 2-2: Electron energy band diagrams<sup>9</sup>

<sup>6</sup> Yoon, R.H. et al., 2001, 37

<sup>7</sup> Hollemann, A.F. and E. Wiberg, 1985, 731-734

<sup>8</sup> Manouchehri, H.R., 2000, 167

<sup>9</sup> Schubert, H., 1996, 209

Most minerals, e.g. calcite, quartz and feldspar, can be considered as semi-conducting solids. Unfortunately, the energy state of the outermost electrons is for insulators and semi-conductors not as exactly to define as for metals.

## 2.2. Mechanism of Charge Transfer

When coming into contact, the participating surfaces exchange charge between their surface states until their uppermost filled levels are thermodynamically equilibrated. The extent of charge transfer is equivalent to the difference in the *surface work functions*  $\Delta\Phi = \Phi_1 - \Phi_2$  of the contacting partners. The work function is the energy required to remove an electron from its *Fermi level*  $E_F$ , which can be considered to be the energy level inside the particle where the probability of finding an electron is one half<sup>10</sup> (Figure 2-3). In the case of an insulator, this surface state theory has some conceptual problems as it assumes the existence of electronic surface states, something virtually impossible due to the low mobility of the charge carriers. An extensive review on that apparent inconsistency is given by Schein.<sup>11 12</sup>

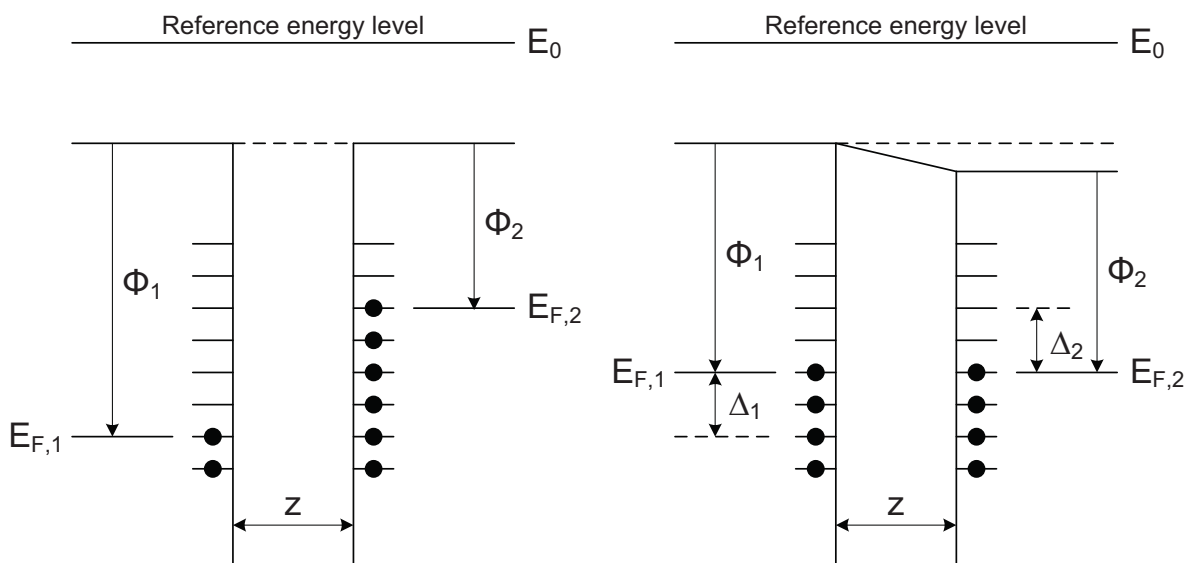

Figure 2-3: Mechanism of charge transfer before (left) and after (right) contact<sup>13</sup>

Initially, the surface states are filled to the Fermi levels  $E_{F,1}$  and  $E_{F,2}$ , respectively. When coming into contact, electrons flow from the material with the lower work function ( $\Phi_2$ ) to that with the higher work function ( $\Phi_1$ ) until the Fermi levels of the both surfaces are equal.

<sup>10</sup> Lee, J.-K. and J.-H. Shin, 2003, 573

<sup>11</sup> Schein, L.B., 1999, 30-33

<sup>12</sup> Schein, L.B., 2000, 475-476

<sup>13</sup> Manouchehri, H.R., 2000, 10

Thus, the charge exchanged between two materials can be represented by<sup>14</sup>

$$Q \propto (\phi_1 - \phi_2 - Ezq) \quad (2-1)$$

where

$Q$  is the charge exchanged,

$\Phi_i$  are the surface work functions,

$E$  is an externally applied field,

$z$  is the separation distance between the contacting partners when charging ceases and

$q$  is the carrier charge.

An estimation of the charge polarity can be derived from Equation (2-2):

$$\Phi = \frac{q_e^2}{4x} \frac{\varepsilon + 7}{\varepsilon + 1} \quad (2-2)$$

where  $q_e$ ,  $x$  and  $\varepsilon$  are the electron charge, distance of the electron from the surface, and dielectric constant, respectively. Accordingly, it can be assumed that larger particles tend to acquire positive charge, while smaller are preferably charged negatively during triboelectrification. Furthermore, a lower dielectric constant obviously results in a higher work function.<sup>15</sup>

Quite a few equations have been derived to quantitatively estimate the effective amount of charge attainable on a particle surface by frictional charging.<sup>16</sup> Actually, the maximum surface charge density is limited by the breakdown strength of air as an insulator to the value of  $22.6 \cdot 10^{-6} \text{C/m}^2$ . Additionally, the stated equations are of limited use as variations on the particle surface conditions (shape, presence of sharp edges, surface contamination etc.) are not taken into consideration.

Manouchehri figured out that the charge to mass ratio  $Q/m$  increases as the particle size is decreased. Moreover, the imparted magnitudes are significantly higher for particles with irregular surface.<sup>17</sup>

<sup>14</sup> Schein, L.B., M. LaHa and D. Novotny, 1992, 79-80

<sup>15</sup> Manouchehri, H.R., 2000, 11-12

<sup>16</sup> Manouchehri, H.R., 2000, 202-203

<sup>17</sup> Manouchehri, H.R., 2000, 238-241

However, the magnitude of the final charge will be essentially dependent on the charge back-flow occurring as the materials are departed, which is strongly influenced by material properties (e.g. surface conductivity, shape and roughness of particle), ambient circumstances (temperature and humidity) and contact conditions (kind and speed of surface separation).

### 2.3. Triboelectrostatic Separators

The essential features of a triboelectrostatic (= free-fall) separator are illustrated in Figure 2-4. Particles acquire charge by contact with other particles or a third (= tribocharger) medium, enter the separation chamber and are subjected to a static electric field that is present between two plate electrodes of equal but opposite charge. Due to the polarity of their electric charge, particles are deflected to the electrode with the inverse charge and collected by adjustable splitters.

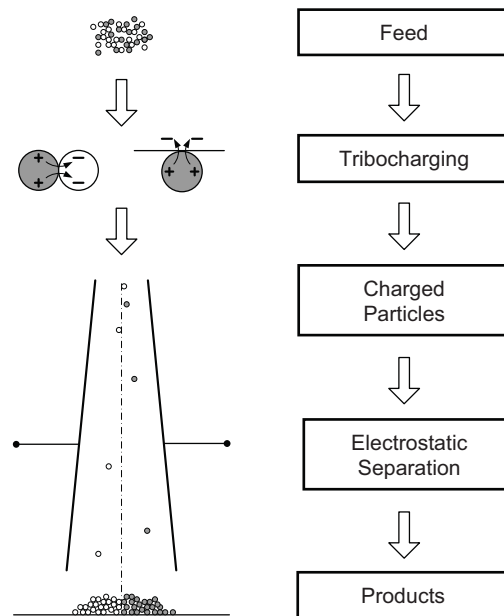

Figure 2-4: Schematic illustration of a triboelectrostatic separator<sup>18 19</sup>

#### 2.3.1. Competing Forces

The significant forces acting on a charged particle in a free-fall separator are the gravitational ( $F_g$ ), drag ( $F_d$ ) and electric ( $F_e$ ). The *gravitational force* is given by

$$F_g = \frac{1}{6} \pi d^3 \rho_s g \quad (2-3)$$

<sup>18</sup> Schubert, H., 1996, 226

<sup>19</sup> Lee, J.-K. and J.-H. Shin, 2003, 573

where

- $d$  is the particle diameter,
- $\rho_s$  is the particle density and
- $g$  is the gravitational acceleration.

Newton defined the resistance of a spherical particle to flow in a fluid<sup>20</sup> (*drag force, fluid friction, sliding resistance*) generally as

$$F_d = c_d \frac{\rho_f v^2}{2} \frac{d^2 \pi}{4} \quad (2-4)$$

where

- $c_d$  is the drag coefficient,
- $\rho_f$  is the fluid density and
- $v$  is the terminal velocity.

In the laminar flow region,  $c_d$  can be replaced by

$$c_d = \frac{24}{\text{Re}} \quad (2-5)$$

$\text{Re}$  is the dimensionless *Reynolds number*:

$$\text{Re} = \frac{d v \rho_f}{\eta} \quad (2-6)$$

where

- $\eta$  is the dynamic viscosity of the fluid.

Equations (2-4)–(2-6) can be combined to give an expression for fluid friction under laminar flow conditions:

$$F_d = 3\pi \eta d v \quad (2-7)$$

---

<sup>20</sup> Kelly, E.G. and D.J. Spottiswood, 1995, 62-72



The *electric force* can be formulated as<sup>21</sup>

$$F_e = qE = A_p \sigma E \quad (2-8)$$

where

- $q$  is the electric charge of the particle,
- $E$  is the electric field strength,
- $A_p$  is the surface area of the particle and
- $\sigma$  is the surface charge density of the particle.

The *electric field strength* of a parallel plate capacitor can be written as

$$E = \frac{dV}{ds} \quad (2-9)$$

where

- $V$  is the electric potential difference of the capacitor and
- $s$  is the perpendicular distance between the plates.

The *total charge*  $Q$  on the plate is proportional to  $V$  and can be expressed as

$$Q = CV = \frac{\varepsilon A}{s} V \quad (2-10)$$

where

- $C$  is the capacitance and
- $A$  is the plate area.

By combining the Equations (2-9) and (2-10) it can be inferred that

$$E = \frac{1}{\varepsilon} \frac{Q}{A} \quad (2-11)$$

To characterise the operation of a plate-type electrostatic separator, a *lifting factor* can be defined as the ratio of electric and gravitational force<sup>22</sup>:

<sup>21</sup> Fricke, H., H. Frohne and P. Vaske, 1976, 180-206

<sup>22</sup> Kelly, E.G., and D.J. Spottiswood, 1995, 298

$$\frac{F_e}{F_g} = \frac{6 A_p \sigma E}{\pi d^3 \rho_s g} \propto \frac{1}{d} \quad (2-12)$$

Accordingly, the tendency of a particle to be deflected increases inversely proportional to the first power of its diameter.

### 2.3.2. Tribocharging Devices and Media

In triboelectrostatic separation systems, charge generation usually occurs when the granular particles are contacted with the walls of containers, chutes, pipes, etc. or with other in the separation process participating mineral matter. Stronger contact obviously results in higher charges on the mineral surfaces. Thus, particular kinds of tribocharging devices have been developed in order to impart charges more effectively on mineral grains:

- Cyclone tribochargers<sup>23 24</sup>
- Rotating drum tribochargers
- Fluidised-bed tribochargers<sup>25 26</sup>
- Ejector tribochargers<sup>27 28</sup>

The charging devices differ in capacity, contact time, probability of contact and consistency of charge magnitude and polarity. Additionally, the charge acquisition is substantially affected by the medium of the tribocharger. As can be derived from Equation (2-1), the work function of the tribocharging medium has substantial influence on the extent of the electron transfer.

For a given combination of minerals, different charges are attained when using diverse tribocharging materials. An extensive review on tribocharging media was presented by Manouchehri.<sup>29</sup>

<sup>23</sup> Dodbiba, G. et al., 2002, 63-92

<sup>24</sup> Manouchehri, H.R., K. Hanumantha Rao and K.S.E. Forssberg, 2002, 9-32

<sup>25</sup> Lee, J.-K. and J.-H. Shin, 2003, 573-574

<sup>26</sup> Inculet, I.I. and M.A. Bergougnou, 1973, 377-390

<sup>27</sup> Kim, J.-K. and S.-C. Kim, 2001, 531-534

<sup>28</sup> Soong, Y. et al., 1998, 393-395

<sup>29</sup> Manouchehri, H.R., 2000, 28-48

## 2.4. Factors affecting Triboelectrostatic Separation Process

The acquisition of the triboelectric charge and the behaviour of the charged particle in an applied electric field can be influenced by several parameters, which can be divided into two major categories: equipment characteristics and material properties.<sup>30</sup> The optimisation of the operating conditions remains a highly empirical process as the effect of each parameter is quite difficult to isolate.

### 2.4.1. Material Properties

– Sample Temperature<sup>31 32</sup>

Each of the electrical properties (work function, electrical conductivity and dielectric constant) is affected to some degree by a change in temperature. As most minerals come under the semi-conductor or insulator category, the *conductivity*  $\sigma$  increases with an elevation in temperature according to

$$\sigma = \sigma_0 e^{\frac{-V_g}{2kT}} \quad (2-13)$$

where

$\sigma$  is the conductivity (S/m) at a given absolute temperature T,

$\sigma_0$  is the conductivity (S/m) at absolute zero,

$V_g$  is the energy gap (eV) and

$k$  is the Boltzmann constant.

By taking the logarithm, replacing the conductivity with the reciprocal of the *resistivity*  $R$  and introducing the *constants*  $A$  and  $B$ , Equation (2-13) can be written as

$$-\log \sigma = \log R = A + \frac{B}{T} \quad (2-14)$$

As illustrated in Figure 2-5, the logarithm of the resistivity exhibits linear dependence on the reciprocal of the absolute temperature.

<sup>30</sup> Manouchehri, H.R., 2000, 105

<sup>31</sup> Fraas, F., 1962, 69-76

<sup>32</sup> Manouchehri, H.R., 2000, 111-117

However, it has been reported that the resistivity of some minerals does not change when temperature is increased. For conductors, the conductivity decreases with an increase in temperature.

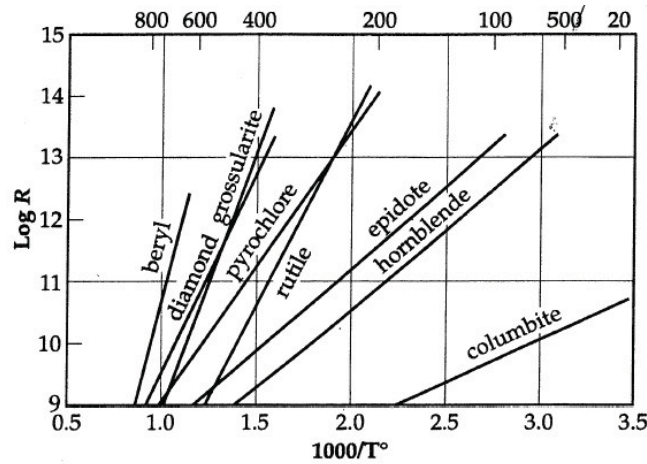

Figure 2-5: Resistivity as a function of temperature for some minerals

Temperature also affects other electro-physical properties, i.e. dielectric constant and contact potential. As stated in section 2.2, the acquired charge is related to the difference in the work functions of the contacting partners. Though, the work function of mineral surface depends on the temperature in a very complicated manner. The dielectric constant usually shows an increase when temperature is elevated.<sup>33</sup>

– Ambient Humidity<sup>34</sup>

Schniewind applied controlled humidity for the electrostatic beneficiation of coal as early as 1915. In 1939, Fahrenwald et al. obtained a patent on humidity control for the separation of rutile from zircon.

Variations in the relative humidity of the surroundings influence both acquisition of surface charge and conductivity. The *surface conductivity*  $\sigma$  of insulating materials can be related quantitatively to the ambient humidity according to:

$$\log \sigma = aH + b \quad (2-15)$$

<sup>33</sup> Kumar, K.K. and L. Sirdeshmukh, 1996, 559-565

<sup>34</sup> Manouchehri, H.R., 2000, 117-120

where

$H$  is the relative humidity and  
 $a, b$  are constants depending on the mineral characteristics.

The avidity of a mineral surface to adsorb water is related to the humidity of the ambient air. As water can act both as electron donor and acceptor, its adsorption will lead to an alteration in the energetic structure and subsequently in the magnitude and polarity of the surface charge. Similar effects can be noticed in the case that water reacts with the surface and induces thereby the formation of a new chemical compound with different electro-physical properties. Moreover, air humidity affects the extent of charge back-flow due to the variations in surface conductivity.

It is worth mentioning that heating the sample is conterminous with decreasing the ambient humidity. In both cases, the superficial adsorption of water on the mineral is repressed. However, by adjusting the ambient humidity the formation of adsorbed water on the mineral surface can be regulated in order to facilitate or improve separation. Hence, humidity effects play a paramount important role in the electrostatic separation process.

#### – Particle Size and Shape of Minerals

The effect of particle size and shape can be derived from following considerations<sup>35</sup>: The particle may be assumed to be an ideal rectangular prism having the *principal dimensions*  $x$ ,  $ax$  and  $bx$ , where  $x$  is the major dimension and  $a \leq b \leq 1$ . Then, gravitational, electrostatic and drag force will be given by

$$F_g = K_1 (ab)x^3 \quad (2-16)$$

$$F_e = K_2 (a + b + ab)x^2 \quad (2-17)$$

$$F_d = K_3 (ab)^{\frac{1}{3}} x \quad (2-18)$$

where  $K_1$ ,  $K_2$  and  $K_3$  are constants. Relating fluid force and electrostatic force, respectively, to gravitational force, the following equations are obtained:

---

<sup>35</sup> Manouchehri, H.R., 2000, 25-28

$$\mathfrak{R}_{eg} = \frac{F_e}{F_g} = \frac{2K_2}{K_1} \frac{1}{x} \left\{ 1 + \frac{1}{a} + \frac{1}{b} \right\} \quad (2-19)$$

$$\mathfrak{R}_{dg} = \frac{F_d}{F_g} = \frac{K_3}{K_1} \frac{1}{x^2} \frac{1}{(ab)^{\frac{2}{3}}} \quad (2-20)$$

From equation (2-19) it follows that the electrostatic force decreases more slowly than the gravitational force with decreasing particle size. Hence, lower electric field strengths may be necessary for the separation of fines.

In the case of a cubic particle ( $a = b = 1$ ), the equations (2-19) and (2-20) can be written as

$$\mathfrak{R}_{eg,cubic} = \frac{K_2}{K_1} \frac{6}{x} \quad (2-21)$$

$$\mathfrak{R}_{dg,cubic} = \frac{K_3}{K_1} \frac{1}{x^2} \quad (2-22)$$

In Figure 2-6, the ratios  $\mathfrak{R}_{eg} / \mathfrak{R}_{eg,cubic}$  and  $\mathfrak{R}_{dg} / \mathfrak{R}_{dg,cubic}$  are plotted against the *coefficient a*, where  $x$  is considered constant and  $b = 1$ .

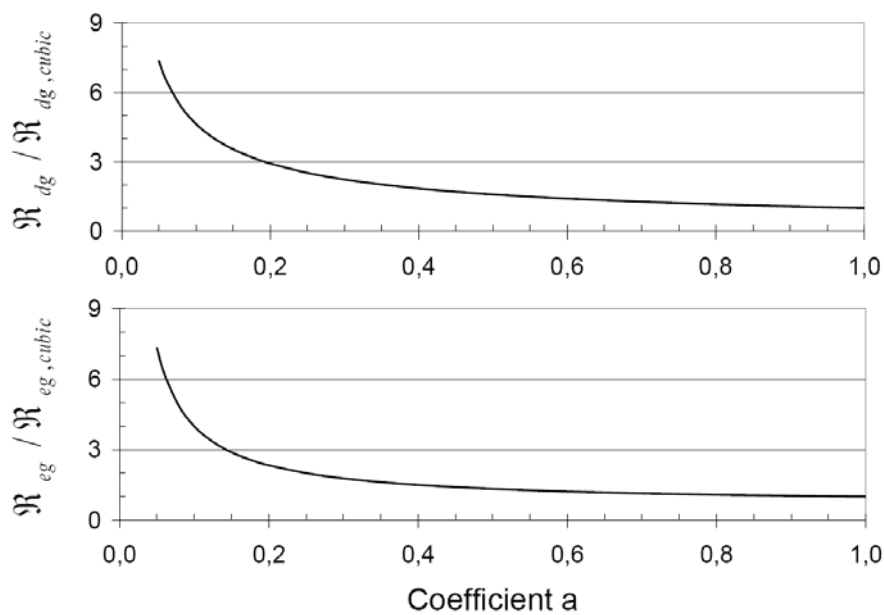

Figure 2-6: Dependence of force ratios on particle shape

Thus, as the diameter of the particle is decreased, the ratios  $\mathfrak{R}_{eg}$  and  $\mathfrak{R}_{dg}$  increase more rapidly for flat than for stout or cubic particles.

As the separating forces in frictional electrification obviously act in opposite directions, close sizing is not always absolutely required. Nevertheless, commercial application of triboelectrostatic separation is certainly restricted regarding feed size. At large particle sizes, the gravitational force will prevail, and the particles won't be deflected sufficiently from their initial path to allow separation. On the other hand, the ratio of fluid friction to gravitational force increases as the particle diameter decreases so that the material has less tendency to be free falling. Consequently, conventional separators fail in the range of  $<0.045\text{mm}$ .<sup>36</sup> To steer clear these difficulties and allow purification of fines, novel types of separators have been developed recently, e.g. by Separation Technologies Inc.<sup>37 38</sup>

Dielectric constant and conductivity also change when the particle size is varied. Mostly, the dielectric constant decreases and the conductivity increases with decreasing particle diameter.

#### – Surface Treatment<sup>39</sup>

The electro-physical properties of mineral surfaces are the basis of electrostatic separation. Both surface conductivity and surface energy states may be modified selectively when a proper surface treatment is applied. This may be of particular concern when the work functions of the surfaces do not differ notably. Methods for surface pre-treatment are manifold and contain physical treatment, chemical conditioning, irradiation and, in a broader sense, thermal treatment.

The presence of certain substances on the particle surface can be critical in triboelectrification. In some cases, the removal of surface coatings, organic matter or adhering solid particles may be imperative to allow separation. Both attrition treatment and chemical action successfully proved for surface cleaning.

In other instances, forming a surface film by reagent adsorption may create favourable conditions for mineral separation. Selective adsorption of chemicals, either by chemisorption

---

<sup>36</sup> Fraas, F., 1962, 93-98

<sup>37</sup> Bittner, J.D. and S.A. Gasiorowski, 2001

<sup>38</sup> Whitlock, D. et al., 1995

<sup>39</sup> Fraas, F., 1962, 59-65

or by physisorption, causes a modification of the valence states. For example, by acquiring selective hydrophobicity, the affinity for water and subsequently the amount of water adsorbed on the mineral surface can be regulated. Alternatively, oxidising or reducing agents may be capable of modifying the electrical behaviour of minerals.

### 2.4.2. Equipment Characteristics

#### – Position of the Electrodes

In the case of a plate-type free-fall separator, the electrode position is determined by the inclination of the plate electrodes and the gap between them. As can be derived from Equation (2-9), the electric field density and its distribution are affected by the position of the electrodes. The further the spacing increases the more decreases the field strength. Earlier studies indicate that the optimum electrode arrangement is dependent on both feed rate and particle size.

#### – Position of the Splitters

The splitter position does neither affect the phenomenon of charge generation nor the particle trajectories in an electric field, but it influences the grade and recovery of the products. Therefore, by adjusting number and position of the splitters, the grade and recovery of the final product may be improved.

#### – Electric Potential Difference

According to Equations (2-8) and (2-9), the electric force acting on charged particles and subsequently the balance between the co-acting forces can be changed by modifying the electric potential difference between the deflector plates. In most cases, better separation results were obtained at higher electric field strengths.<sup>40 41 42</sup>

From Equation (2-12) it can be inferred that the proper electric voltage for satisfactory separation shows dependence on size, density and electro-physical properties of the mineral grains. Therefore, an increased electric potential difference needs not necessarily imply enhanced separation results.

---

<sup>40</sup> Kim, J.-K. and S.-C. Kim, 2001, 535

<sup>41</sup> Lee, J.-K. and J.-H. Shin, 2003, 579

<sup>42</sup> Pearse, M.J. and M.I. Pope, 1976, 11



– Feed Rate

In commercial separator operations, the desire for maximum capacities with acceptable separation performance is obvious. The decline of separation efficiency in electrostatic separation processes when increasing the throughput has been reported in numerous papers.<sup>43 44 45</sup> On the contrary, Fraas<sup>46</sup> stated Hudson who had described the triboelectrostatic separation of calcite from quartz using an inclined-plate separator. Thereby, the feed rate could be increased without much loss in grade and recovery.

---

<sup>43</sup> Hangsubcharoen, M. et al., 2000, 3

<sup>44</sup> Kim, J.-K. and S.-C. Kim, 2001, 534-535

<sup>45</sup> Pearse, M.J. and M.I. Pope, 1976, 12

<sup>46</sup> Fraas, F., 1962, 123

### 3. Test Material Characterisation

The determination of the raw material characteristics is an essential prerequisite in mineral processing technology. The feed material used in the present investigation originates from a closed mill circuit of a calcium carbonate processing plant in Canada and was characterised regarding mineralogical and chemical composition, particle size, liberation and electro-physical properties.

#### 3.1. Mineralogy

The typical marble quarried is a medium to coarse grained, homogenous and strongly metamorphosed rock of white colour, with a distinct mosaic fabric. Interstratifications of amphibolite layers, calc-silicate rocks and accumulations of quartz-feldspar lenses and layers appear partly in the marble. The amount of abrasive and colouring constituents is very low. Isometric crystals of pyrite are chiefly associated to the siliceous layers. Thin sections of diverse marbles under a polarised microscope (magnification 12x and 10x, respectively) are given in Figure 3-1.

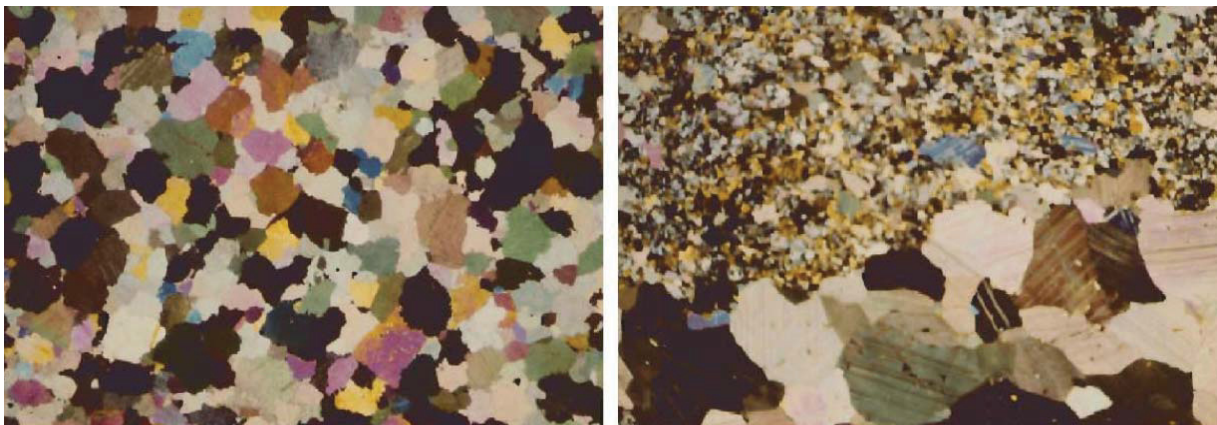

**Figure 3-1:** Typical high-grade marble with mosaic structure (left) and coarse grained marble in contact to calc-silicate rock (right)

The major mineral phases associated with marble (calcite-dolomite accompanying minerals) were determined by microscopy and diffractometry. Crystals of pyrite and pyrrhotite under a stereomicroscope are depicted in Figure 3-2.

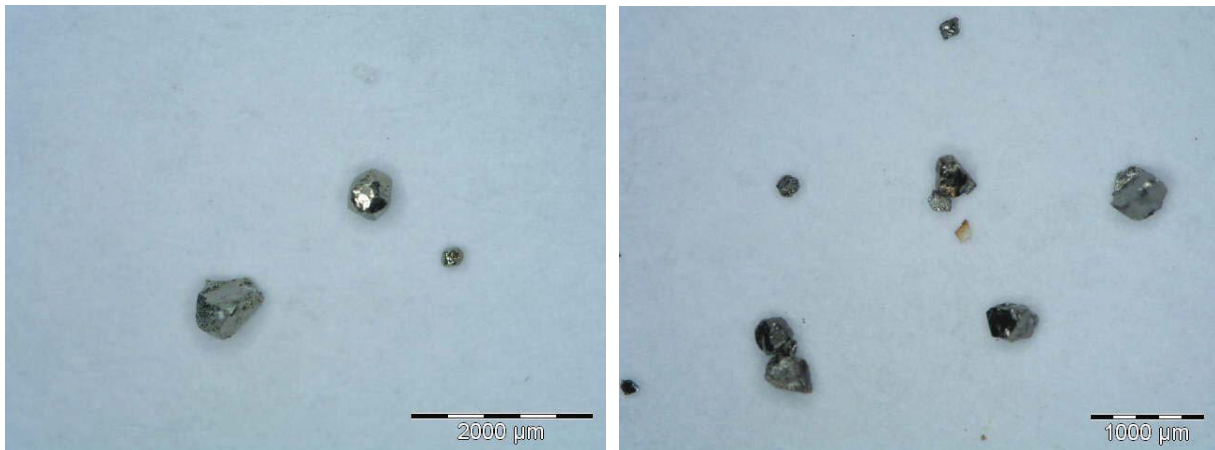

Figure 3-2: Pyrite (left) and pyrrhotite (right) crystals under stereomicroscope

For the semi-quantitative determination of the non-carbonatic constituents' mineralogical composition, a typical marble sample was ground to <0.400mm in size and dissolved in hot diluted hydrochloric acid (chemical formula HCl). Both calcite and dolomite dissolve in hydrochloric acid. The insoluble constituents were filtrated, dried and subjected to XRD for phase identification (figure 3-4). The identified mineral phases and their relative abundance (maj = major; min = minor; tr = trace) are given in Table 3-1.

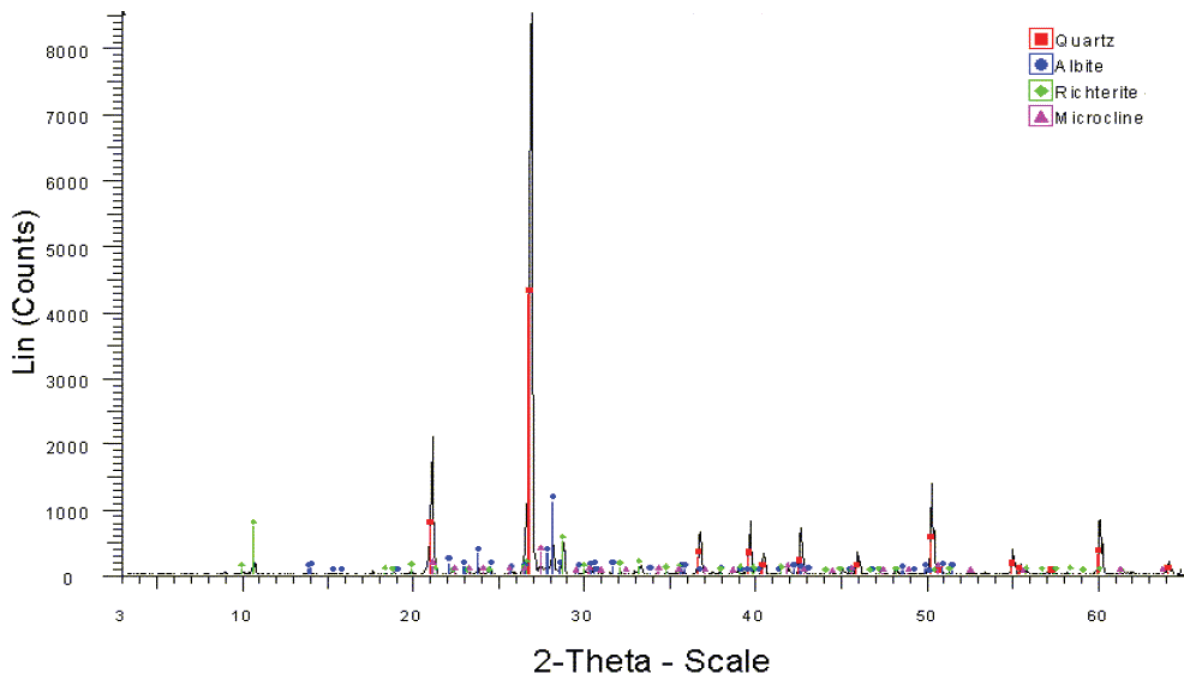

Figure 3-3: X-ray diffraction pattern of HCl-insoluble residue of marble sample

Mineral		Chemical formula	r.a.
Quartz		SiO <sub>2</sub>	maj
Feldspars	Albite	Na[AlSi <sub>3</sub> O <sub>8</sub> ]	min
	Microcline	K[AlSi <sub>3</sub> O <sub>8</sub> ]	min
Amphiboles	Hornblende	(K,Na)(Ca,Na) <sub>2</sub> (Mg,Fe <sup>2+</sup> ,Fe <sup>3+</sup> ,Al) <sub>5</sub> [(OH,F) <sub>2</sub> /(Si,Al) <sub>2</sub> Si <sub>6</sub> O <sub>22</sub> ]	min
	Richterite	Na <sub>2</sub> Ca(Mg,Fe <sup>2+</sup> ,Mn,Fe <sup>3+</sup> ,Al) <sub>5</sub> [(OH) <sub>2</sub> /Si <sub>8</sub> O <sub>22</sub> ]	min
Micas	Phlogopite	KMg <sub>3</sub> [(OH,F) <sub>2</sub> /Si <sub>3</sub> AlO <sub>10</sub> ]	tr
	Biotite	K(Mg, Fe <sup>2+</sup> ) <sub>3</sub> [(OH) <sub>2</sub> /Si <sub>3</sub> (Al,Fe <sup>3+</sup> )O <sub>10</sub> ]	tr
Sulfides	Pyrite	FeS <sub>2</sub>	tr
	Pyrrhotite	FeS	tr

**Table 3-1:** Main mineralogical composition of the HCl-insoluble residue of marble sample

### 3.2. Chemical Composition

The chemical composition of the marble sample was investigated by wavelength-dispersive X-ray fluorescence analysis (WDXRF). Prior to spectrometry, the <0.400mm ground sample was dissolved in a Lithium tetraborate flux at a temperature of 1000°C to form a fused bead for subsequent analysis. The results of the WDXRF are shown in Table 3-2.

Designation	(%)
Ca as CaO	50.9
Mg as MgO	0.9
Si as SiO <sub>2</sub>	8.2
Fe as Fe <sub>2</sub> O <sub>3</sub>	0.2
Al as Al <sub>2</sub> O <sub>3</sub>	0.3
Loss on ignition	39.5

**Table 3-2:** Chemical analysis of marble sample by WDXRF

### 3.3. Particle Size

The mineral sample was submitted to dry laboratory hand sieving to determine particle size distribution. The results are plotted in tabular (Table 3-3) and graphic (Figure 3-4) form. The size fraction <2mm represents about 99% of the total mass, the  $d_{50}$ -value amounts to 0.250mm.

Size fraction		Mass (%)	Retained (%)	Cum. passing (%)
Index k	(mm)			
1	2	1,2	1,2	98,8
2	1	5,5	6,7	93,3
3	0,630	8,6	15,3	84,7
4	0,315	21,7	37,0	63,0
5	0,200	25,5	62,5	37,5
6	0,100	31,5	94,0	6,0
7	0,063	4,1	98,1	1,9
8	0	1,9	100,0	0,0
0	Total	100,0	-	-

Table 3-3: Sieve analysis of marble sample

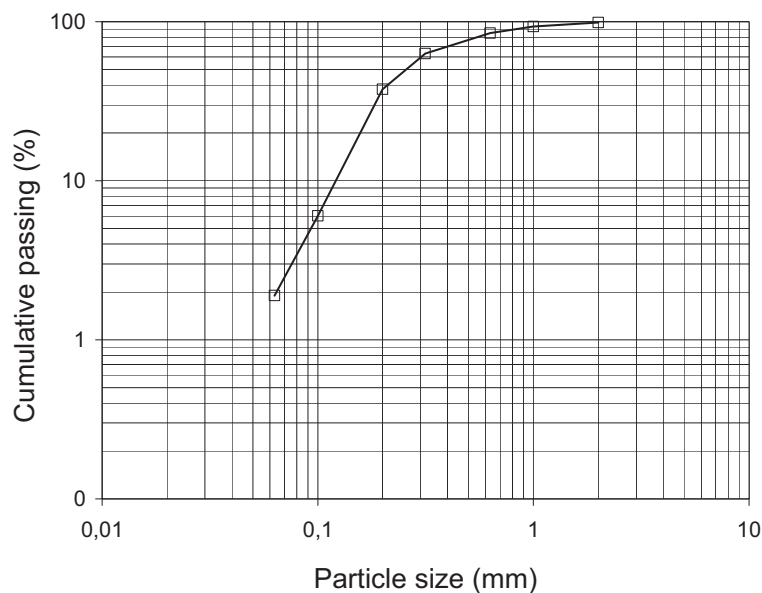

Figure 3-4: Particle size distribution of marble sample (log-log cumulative plot)

To determine the distribution of the carbonate accompanying constituents over the different particle sizes, each sieve fraction was analysed regarding its HCl-insoluble content. Therefore, the size fractions >0.315mm were comminuted in a lab centrifugal mill to <0.400mm. Table 3-4 and

Figure 3-5 show that the size fractions 0.630/0.315mm, 0.315/0.200mm and 0.200/0.100mm, which represent almost 79% of the overall mass, exhibit the highest HCl-insolubles grades. Hence, more than 92% of the insoluble content is comprised in the 0.630/0.100mm fraction.

Index k	Size fraction (mm)	Class			Cumulated product		Complementary product	
		Mass (%)	HCl-Insol.		Mass (%)	HCl-Insol. (%)	Mass (%)	HCl-Insol. (%)
			(%)	Recovery (%)				
1	2	1,16	3,21	0,38	1,16	3,21	100,00	9,86
2	1	5,51	3,81	2,13	6,67	3,71	98,84	9,93
3	0,630	8,65	3,88	3,40	15,32	3,80	93,33	10,30
4	0,315	21,65	7,31	16,06	36,97	5,86	84,68	10,95
5	0,200	25,46	16,24	41,95	62,43	10,09	63,03	12,20
6	0,100	31,56	10,72	34,32	93,99	10,30	37,57	9,46
7	0,063	4,12	3,06	1,28	98,11	10,00	6,02	2,88
8	0	1,89	2,49	0,48	100,00	9,86	1,89	2,49
0	Total	100,00	9,86	100,00	-	-	-	-

Table 3-4: Analysis of sieve fractions regarding HCl-insolubles

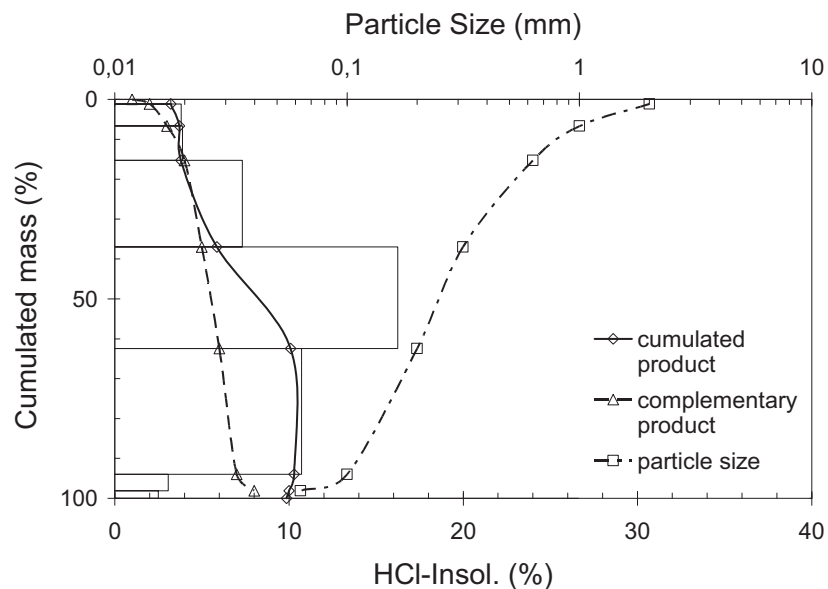

Figure 3-5: Cumulated mass versus cumulated HCl-insolubles

### 3.4. Liberation

Earlier investigations on the present mineral sample demonstrated a degree of liberation of >80% for mineral grains <1mm. Consequently, the size fractions which contain the largest amount of impurities seem to be sufficiently liberated to allow electrostatic beneficiation. In practice, also particles >1mm show a considerable degree of liberation and can therefore be fed to electrostatic separation.

### 3.5. Electrical Properties of Minerals

As stated in chapter 2, the electro-physical properties of mineral surfaces are of paramount interest in triboelectrification phenomena. Table 3-5 shows dielectric constant  $\epsilon$ , electrical conductivity  $\sigma$  and work function  $\Phi$  for the identified minerals in the analysed marble sample. Please note that the electrical conductivity of mineral samples varies even for the same mineral to a large extent. Unfortunately, surface work function values were only available for quartz and calcite.

Mineral	Dielectric constant $\epsilon$	Resistivity $\rho$ ( $\Omega\text{m}$ )	Work function $\Phi$ (eV)
Calcite	7.3-8.7	$1.0 \cdot 10^8 - 1.0 \cdot 10^{14}$	4.316
Quartz	2.3-6.0	$3.8 \cdot 10^{10} - 2.0 \cdot 10^{14}$	4.457
Albite	5.5-7.0	$1.0 \cdot 10^6 - 1.0 \cdot 10^{12}$	-
Microcline	5.5-5.6	$1.8 \cdot 10^{11}$	-
Hornblende, Amphiboles (Richterite)	4.9-8.0	$1.0 \cdot 10^7 - 4.8 \cdot 10^{10}$	-
Phlogopite	5.9-6.5	$1.0 \cdot 10^{11} - 1.0 \cdot 10^{12}$	-
Biotite	6.2-10.3	$1.0 \cdot 10^{-9} - 1.0 \cdot 10^{-12}$	-
Pyrite	33.7-81	$1.5 \cdot 10^0 - 1.0 \cdot 10^{-6}$	-
Pyrrhotite	-	$2.0 \cdot 10^0 - 1.6 \cdot 10^{-8}$	-

**Table 3-5:** Electro-physical properties of minerals present in marble sample<sup>47 48 49 50 51</sup>

<sup>47</sup> Schubert, H., 1996, 237

<sup>48</sup> Manouchehri, H.R, 2000, 37

<sup>49</sup> Beblo, M., 1982, 239-261

<sup>50</sup> Keller, G.V., 1989, 359-378

<sup>51</sup> Schön, J.H., 1996, 387-392

## 4. Experimental Apparatus and Procedure

### 4.1. Triboelectrostatic Separation System

The basic set-up of the triboelectrostatic separation equipment used in the present research is illustrated in Figures 4–1, 4–2 and 4–3. The apparatus is composed of two inclined plate electrodes, high voltage DC generators, a feed hopper, a vibratory feeder, a precharging shaft and the product bins.

The copper electrodes of 50cm width and 150cm height are coated with a plastic foil to avoid that particles discharge or inverse charging when contacting the plates. The spacing between the electrodes can be adjusted from 11–55cm at the top and 20–65cm at the bottom. Two high-voltage DC generators supply the plate electrodes with a potential difference of up to 120kV. 30M $\Omega$  resistances between electrodes and generators protect the DC generators from overloading in the event of arcing between the electrode plates by limiting the current flow in the electrical circuit to less than 680 $\mu$ A.

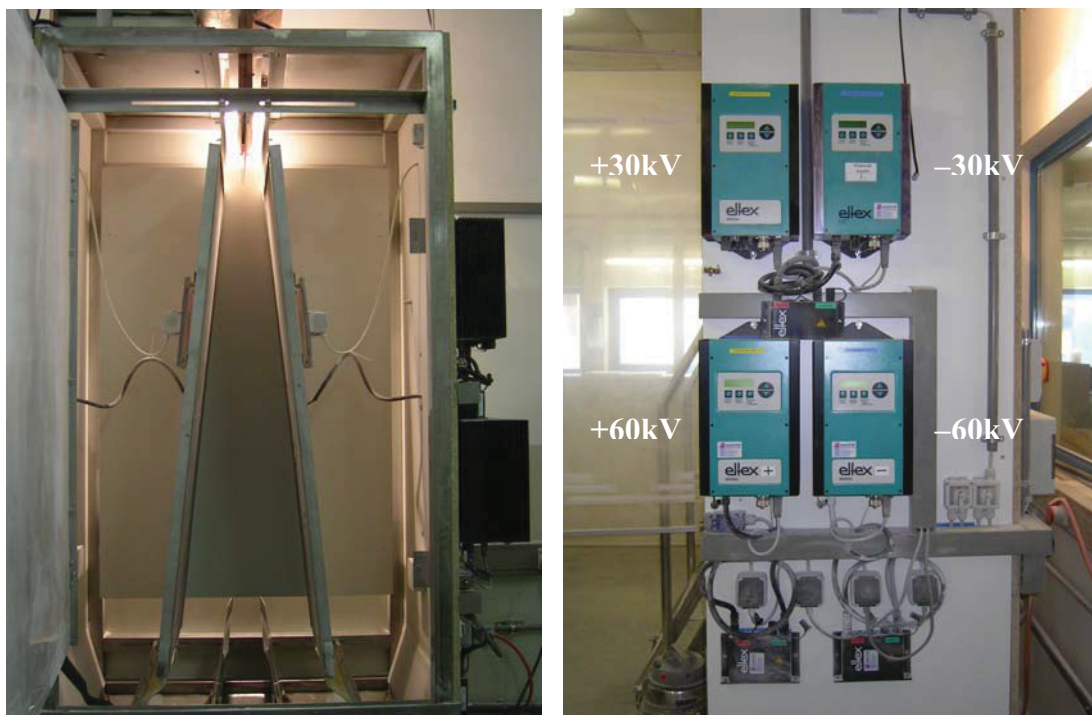
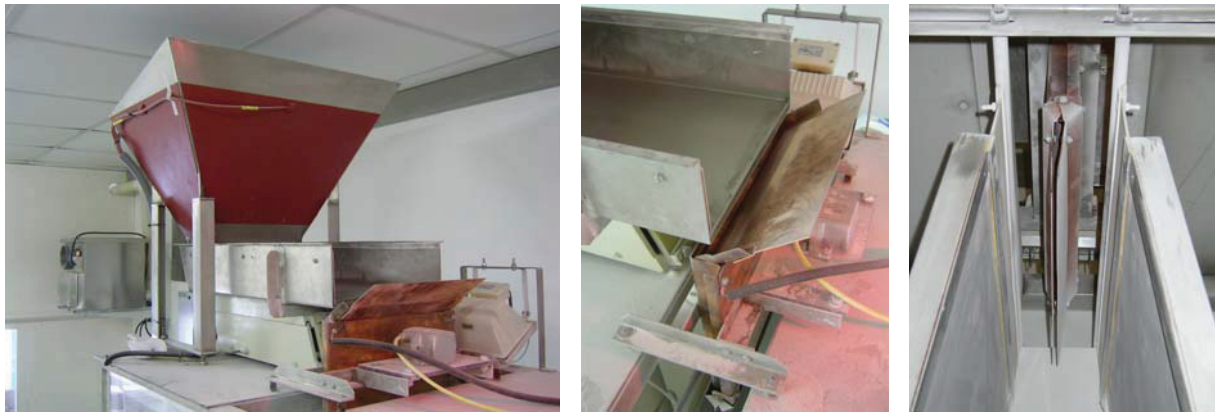

Figure 4-1: Electrostatic separator: plate electrodes (left) and DC generators (right)



Two shafts of copper and stainless steel, respectively, were manufactured to determine the effect of different materials on charge acquisition and separation performance. Figure 4-3 shows the inner workings of the precharging shaft. Both precharging device and plate electrodes are interconnected with vibrating devices in order to prohibit undesirable adhesive accretion of finest particles.

The walls of feed hopper and vibratory feeder are manufactured of stainless steel and can be heated up to 150°C by the means of heating mats. Moreover, the position of the two splitters can be adjusted to the particle trajectories and thereby regulate grade and recovery of the products.



**Figure 4-2:** Feed hopper and vibratory feeder (left) and precharging device (middle and right)



**Figure 4-3:** Inner workings of the precharging shaft

The electrostatic separation system was placed inside a climate chamber to maintain well-defined ambient conditions. Temperature and relative humidity could be varied from 10–40°C and 12–60%, respectively.

## 4.2. Experimental Procedure

### 4.2.1. Prearrangements

As mentioned earlier, the factors affecting the triboelectrostatic separation are manifold and diverse. Not to investigate each possible parameter combination, standard values were predefined for the most important operating factors. During a particular test series, the one contemplated parameter was varied in defined limits, whereas the remaining ones were kept constant at standard conditions. Obviously, this procedure underlies the presumption that the factors are independent from each other, what might not be true without any restrictions. The operating parameters to be monitored are (standard values **bold**):

- Position of splitter at positive electrode: 10 / **20** / 30 / 40 (%)
- Feed rate: 0.25 / 0.5 / **1.0** / 1.5 / 2.0 / 2.5 (kg/ms)
- Feed temperature: 25 / 40 / 60 / **80** / 100 / 120 (°C)
- Ambient humidity: 12 / **20** / 25 / 30 / 40 / 60 (%)
- Feed moisture: <**0.1** / 0.5 / 1 / 2 / 5 (%)
- 0,063mm passing: <**5** / 10 / 15 / 20 / 25 / 60 (%)
- Vibratory feeder temperature: 40 / 80 / **100** / 120 / **150** (°C)
- Precharging shaft material: **copper** / stainless steel

The two electrode plates are spaced 140mm and 430mm apart at the top and bottom, respectively, and maintained at a potential difference of 60kV, or a mean electric field strength of 2.1kV/cm. Except for the test series aimed at investigating the feed rate, ambient temperature was held constant at 40°C.

### 4.2.2. Electrostatic Separation Testing

For each single separation test, 9350g dry and pre-heated mineral sample (100%<5.6mm) were introduced to the separator, approximately 200–400g retained for analysis. Subsequent to the separation, the contents of the three product bins were cooled to room temperature, then weighed and split. The split products and the retained feed sample were comminuted in a laboratory centrifugal mill to <0.400mm to maintain homogeneity and analysed regarding their amount of insoluble residue in hydrochloric acid (Figure 4-4).

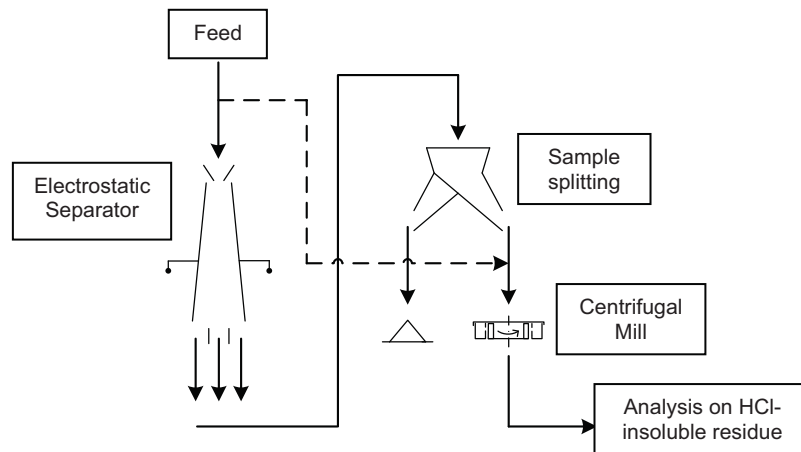

Figure 4-4: Procedure of electrostatic separation tests

Figure 4-5 illustrates the denotation of the separation products: The product at the positive electrode (*positive*) was named *reject* or *tailings*; the middlings (*center*) and the product at the negative electrode (*negative*) were combined and called *concentrate*.

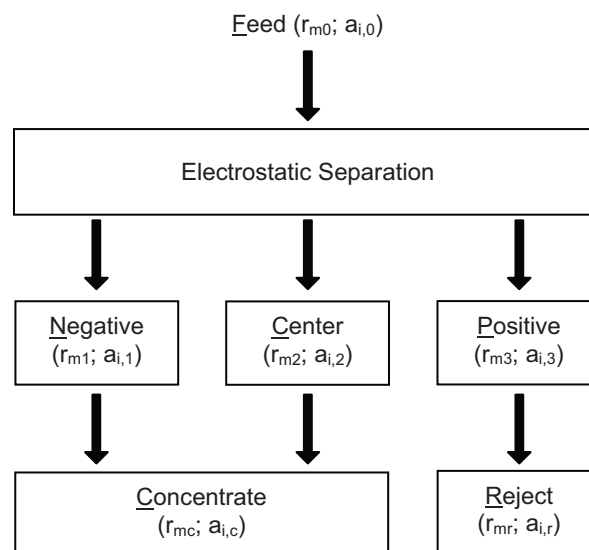

Figure 4-5: Denotation of separation products

The electrostatic separation tests were interpreted by means of a 3-product balance. Values of crucial expressiveness are:

- Grade of insolubles in concentrate and reject
- Recovery of mass in concentrate
- Carbonate loss (= recovery of carbonate in reject)
- Recovery of insoluble residue in reject

Utilising the principle of conservation of mass and matter<sup>52</sup>, the following constitutive equations for the analysis of mineral processing units can be derived:

$$\sum r_{mj} = r_{m0} = 1 \quad (4-1)$$

$$\sum r_{mj} a_{i,j} = r_{m0} a_{i,0} = a_{i,0} \quad (4-2)$$

$$r_{i,j} = r_{mj} \frac{a_{i,j}}{a_{i,0}} \quad (4-3)$$

where

$r_{mj}$  is the mass recovery  $r_m$  in product  $j$  ( $j=0$ : feed,  $j=1$ : negative;  $j=2$ : center;  $j=3$ : positive),

$a_{i,j}$  is the grade  $a$  of component  $i$  ( $i=1$ : insolubles;  $i=2$ : carbonate) in product  $j$  and

$r_{i,j}$  is the recovery  $r$  of component  $i$  in product  $j$ .

---

<sup>52</sup> Kelly, E.G. and D.J. Spottiswood, 1995, 9

## **5. Results of Separation Tests**

As interpreted from the mineralogical and chemical analysis, quartz is undoubtedly the major gangue mineral in the used mineral sample. Calcite (4.316eV) exhibits a lower work function than quartz (4.457eV) and feldspars (4.403eV). Therefore, calcite particles can be expected to be positively charged, quartz and feldspar to be negatively charged during triboelectrification. Hence, the reject at the positive electrode can be assumed to be enriched with siliceous and colouring constituents.

### **5.1. Pre-Tests**

Pre-tests were conducted to estimate the effect of the electric field strength on electrostatic beneficiation. According to Equation (2-9), the electric field strength may be altered by varying either electric potential difference or position of the plate electrodes. A feed containing 93.5% carbonate was concentrated to 98.1% carbonate with a carbonate recovery of approximately 87%. The insolubles grade and recovery in the reject were 28.5% and 76%, respectively.

By decreasing the electric field strength, the carbonate recovery in the concentrate could be improved slightly without significant loss in its carbonate grade. Yet, the extent of influence on the separation performance was very limited.

### **5.2. Parameter Test Series**

The priority objective at this point was to monitor the operating parameters that are supposed to affect triboelectric separation in a very decisive manner. As mentioned earlier, each parameter to be observed was gradually varied in predefined limits, whereas the others were held constant at their standard values. The associated test reports and materials balances are enclosed in the appendix.

### 5.2.1. Splitter Position

(Test Numbers 20 – 25)

The splitter at the positive electrode was varied between 10% and 40% in order to observe changes in grade and recovery (Figure 5-1). As stated earlier, both charge transfer and particle trajectories are not affected when the splitter position is altered.

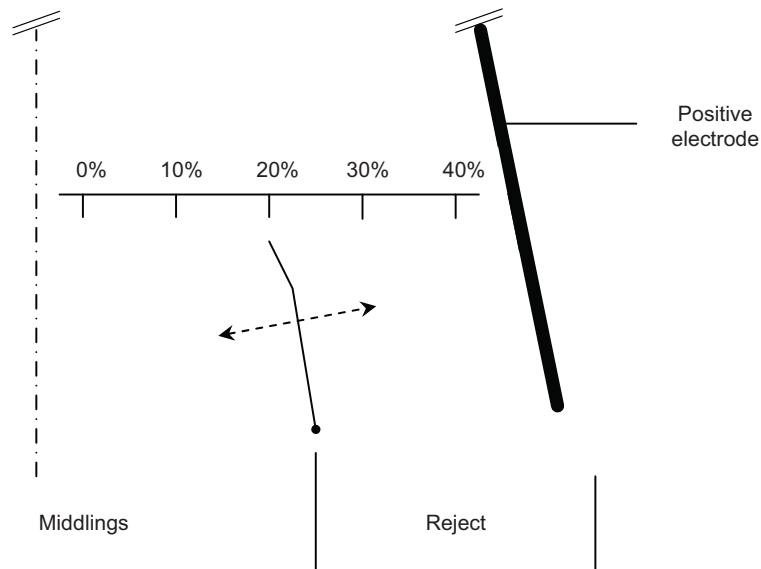

Figure 5-1: Variation of splitter position

The results are depicted in Figures 5-2, 5-3 and 5-4: Grade and recovery are two conflicting criteria in mineral processing operations.<sup>53</sup> As had been expected, the reject's insolubles grade increases and the insolubles recovery decreases when the splitter is moved outwardly.

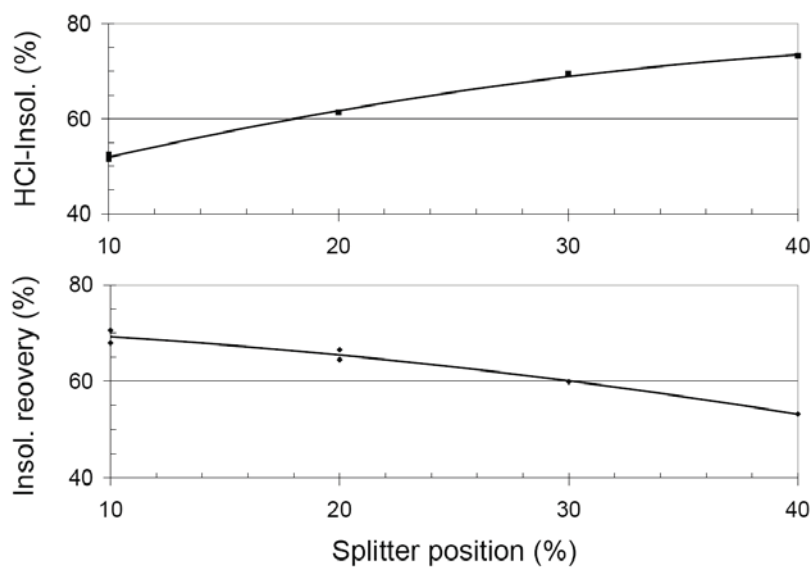

Figure 5-2: Insolubles grade and recovery in reject as a function of splitter position

<sup>53</sup> Kelly, E.G. and D.J. Spottiswood, 1995, 56

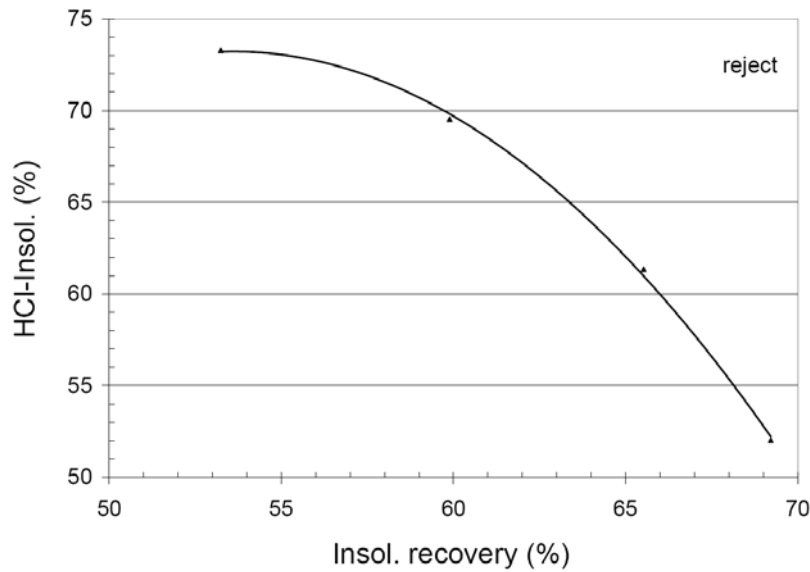

Figure 5-3: Reject: Insolubles grade versus recovery

As a consequence, a central splitter position improves the carbonate grade in the concentrate, but causes significantly higher carbonate losses due to the lower insolubles content in the reject (Figure 5-4).

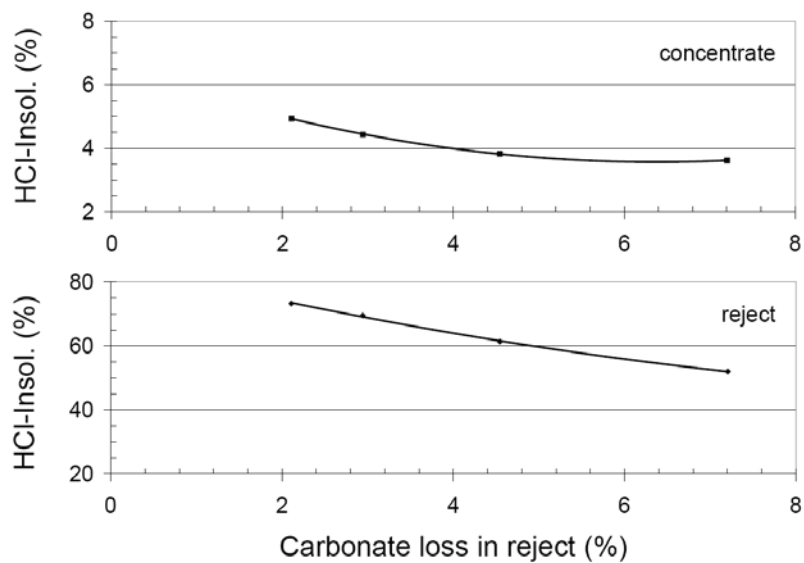

Figure 5-4: Insolubles grade of concentrate and reject as a function of carbonate loss

### 5.2.2. Feed Rate

(Test Numbers 1 – 7)

In mineral processing operations, it is desirable to obtain a maximum feed rate with an satisfactory separation performance. In this study, this parameter was varied from 0.25–2.5kg/ms by adjusting either the intensity of the vibratory feeder or the gap width of the

hopper outlet. Due to lacking operational readiness of the air conditioning system at that particular moment, the separation chamber was heated to 40–44°C by the means of a hot air blower. Thereby, the relative humidity was reduced from 25–28% in the ambient air to 8–10% in the separation chamber.

Figure 5-5 depicts the recovery of mass in the products as a function of the feed rate. At higher capacities, disproportionately more mass was present in the center than in the side fractions. Furthermore, the insolubles recovery in the reject dropped to less than 50% when the throughput was increased to 2.5kg/ms, whereas the insolubles grade decreased only to a very limited extent (Figure 5-6). Consequently, the concentrate contains considerably larger amounts of insoluble constituents at higher feed rates (Figure 5-7).

This reduction in separation efficiency at higher feed rates was primarily attributed to the following causes:

- Charged particles increasingly hinder each other when trying to move according to the balance of co-acting forces in the applied electric field.
- The acquired triboelectric charge is increasingly determined by particle/particle and not by particle/metal contact.

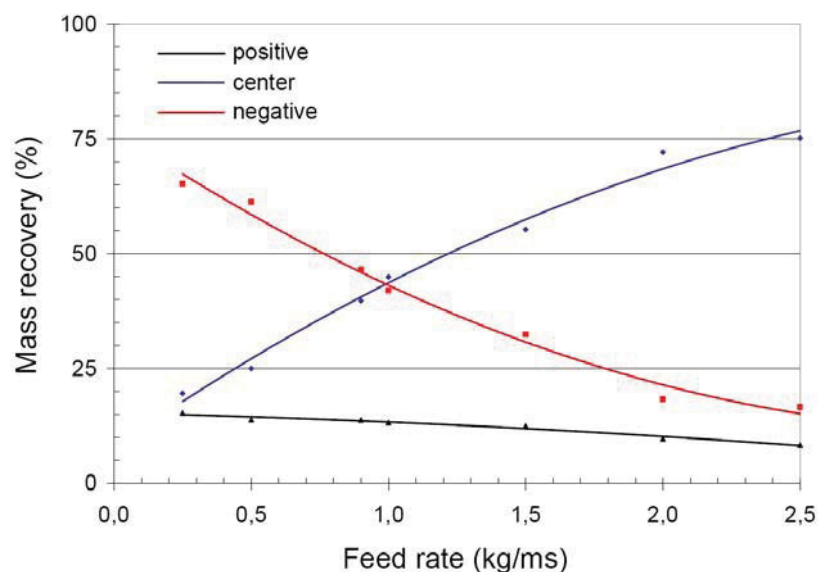

**Figure 5-5:** Mass recovery in electrostatic separation products as a function of feed rate



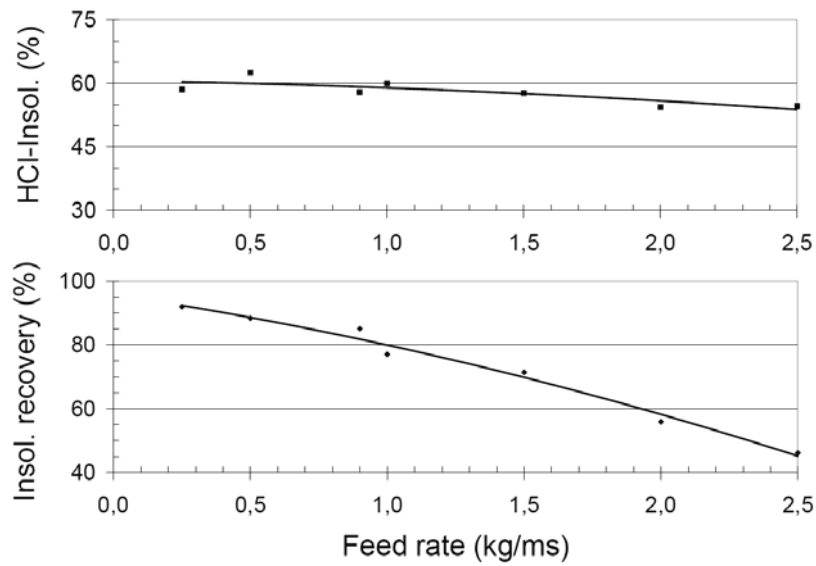

Figure 5-6: Insolubles grade and recovery in reject versus feed rate

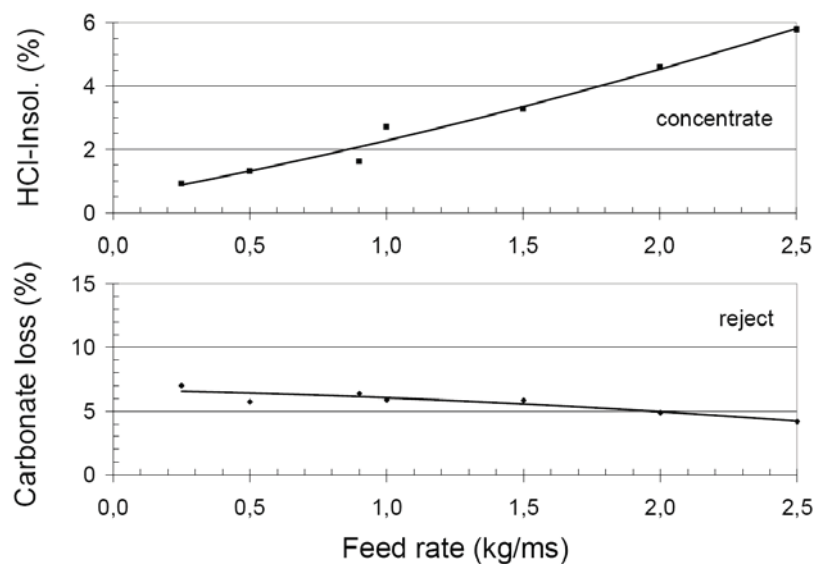

Figure 5-7: Insolubles grade of concentrate and carbonate loss in reject versus feed rate

In this context the question arises whether the observed decline in insolubles recovery can probably be levelled off by increasing the height of the separation chamber and consequently the time of falling for the particles. However, that issue was beyond the scope of the present investigation.

### 5.2.3. Feed Temperature

(Test Numbers 37 – 46)

Hudson<sup>54</sup> varied the sample temperature to improve triboelectric separation of quartz from calcite in Australian dune sands. With the sample unheated, poor separation was obtained. But when heated to 100°C, the 83.9% calcite feed was concentrated to 98.8% calcite with a 95.5% recovery of calcite. Hence, the temperature seems to have paramount importance on the separation results.

In this study, the feed sample temperature was raised from 40°C to 90°C, using copper and stainless steel, respectively, as precharging shaft material. At 40°C, particles acquire their surface charge rather randomly than selectively. Despite high mass recoveries in the side bins (Figures 5-8 and 5-9), no separation was achieved because all three products show almost equal insolubles grades. When elevating the temperature, the selectivity of the electrostatic separation increases. Satisfying results were obtained at 80°C and above (Figures 5-10 and 5-11).

Probable explanations for the improvement of separation efficiency at higher sample temperatures are changes in the charge transfer during triboelectrification. Already Manouchehri<sup>55</sup> noticed that charge magnitudes on mineral surfaces increase when the sample temperature is elevated. Heating the solids may also depress superficial water adsorption in a humid atmosphere and thereby allow better separation results.

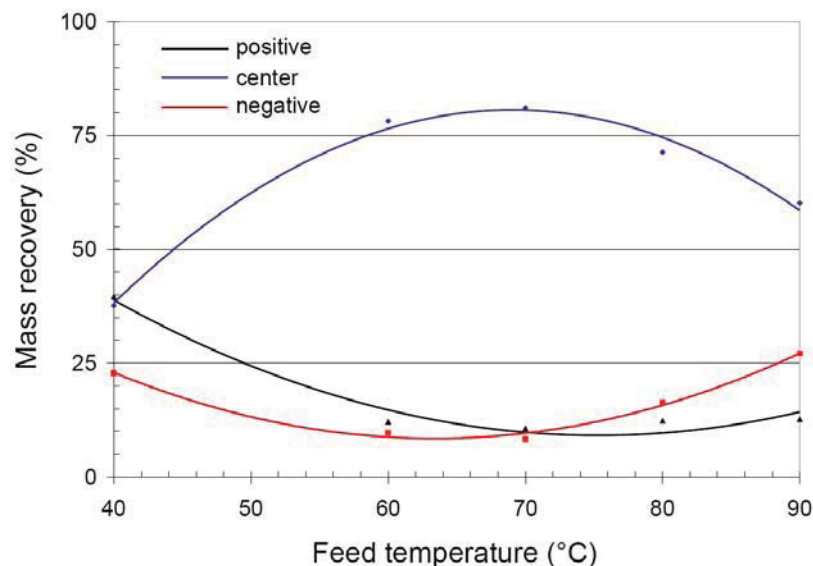

**Figure 5-8:** Mass recovery in separation products at different feed material temperatures using copper as shaft material

<sup>54</sup> Fraas, F., 1962, 123

<sup>55</sup> Manouchehri, H.R., 2000, 29-32

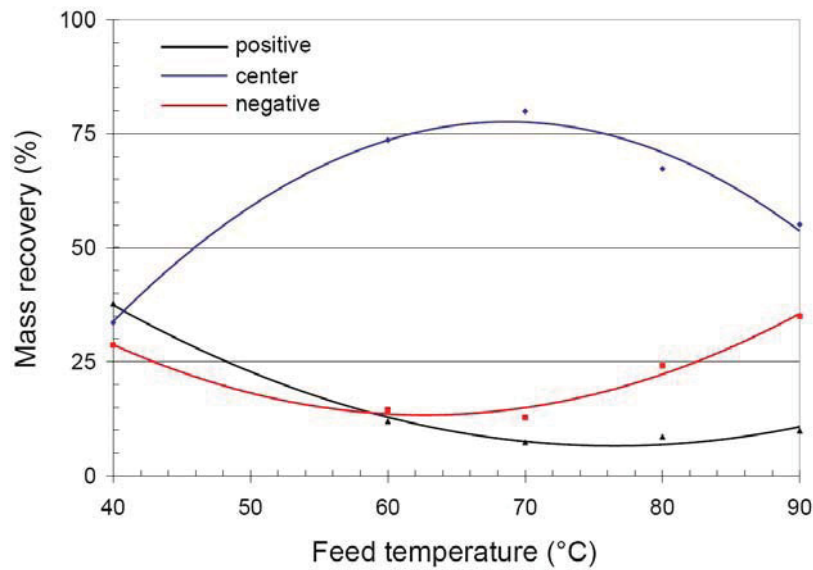

**Figure 5-9:** Mass recovery in separation products at different feed material temperatures using stainless steel as shaft material

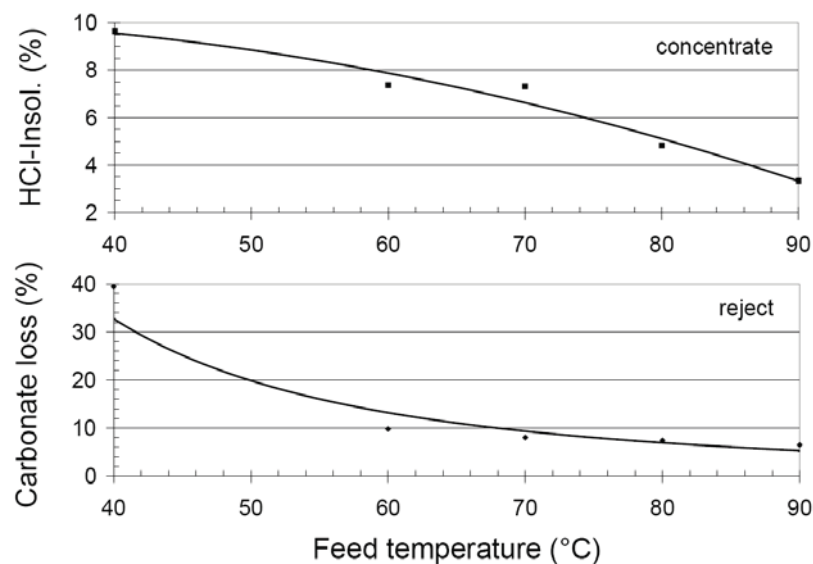

**Figure 5-10:** Concentrate insolubles grade and carbonate loss versus feed temperature using copper as shaft material

The influence of copper and stainless steel as precharging device material can be derived from Figure 5-12. When using stainless steel, higher insolubles grades in the reject were obtained, but not without a certain drop in insolubles recovery. As a consequence, both carbonate loss in the reject and carbonate grade in the concentrate decrease in comparison to the use of copper.

However, these differences in grade and recovery can presumably be compensated by adjusting the splitter position as discussed in section 5.2.1.

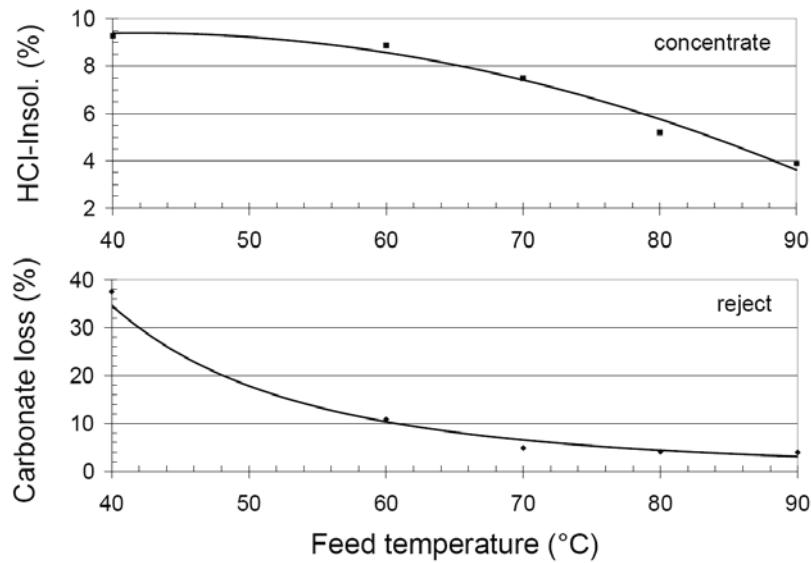

Figure 5-11: Concentrate insolubles grade and carbonate loss versus feed temperature using stainless steel as shaft material

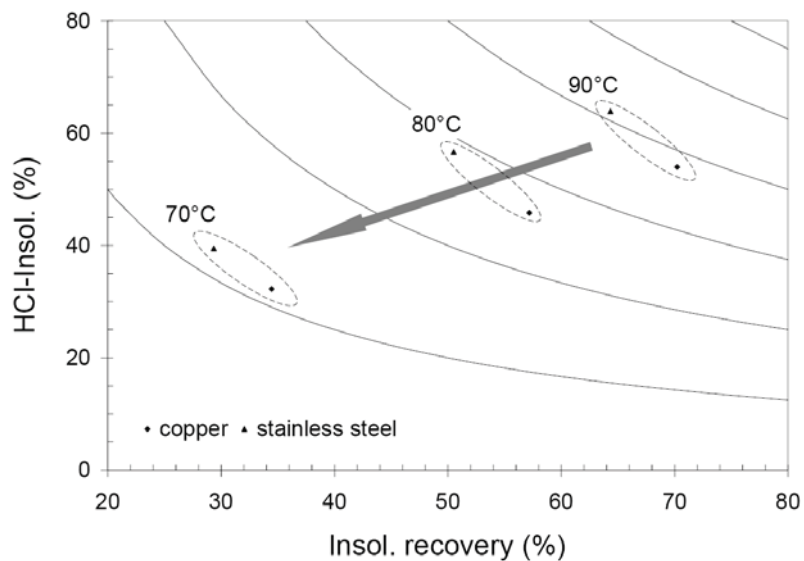

Figure 5-12: Insolubles grade and recovery in reject at different temperatures using copper and stainless steel as tribocharger material

#### 5.2.4. Ambient Humidity

(Test Numbers 8 – 13)

Pearse and Pope<sup>56</sup> investigated the influence of relative humidity on the triboelectric separation of calcite-quartz powders. Therefore, chemically conditioned samples were

<sup>56</sup> Pearse, M.J. and M.I. Pope, 1977, 87

equilibrated in a thermostated container at different humidities for 48 hours. Thereafter, triboelectric separation was carried out under constant ambient conditions at 58% relative humidity and 22°C temperature. Remarkably, variations in the relative humidity during storing had very little effect on the efficiency of the separation.

Triboelectric separation tests on quartz-calcite mixtures at the University of Clausthal<sup>57</sup> showed that magnitude and selectivity of particle charging increase when the ambient humidity is decreased. Unfortunately, especially high charged particles tend to agglomerate, thereby causing a considerable decrease in both grade and recovery.

In the present investigation, changes in the ambient relative humidity had significant influence on the separation process. According to the results, separation performance is adversely affected by increasing relative humidity.

As both insolubles grade and recovery in the reject decreased when the humidity was elevated, the best results were obtained in dry atmosphere. At a relative humidity of 12%, a concentrate containing less than 2% insoluble residue with a carbonate recovery of 94% (or 6% carbonate loss) was achieved.

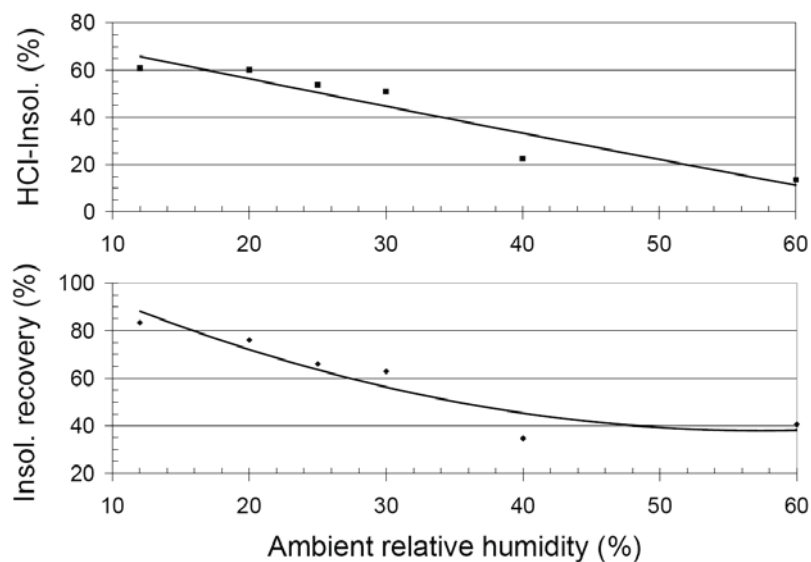
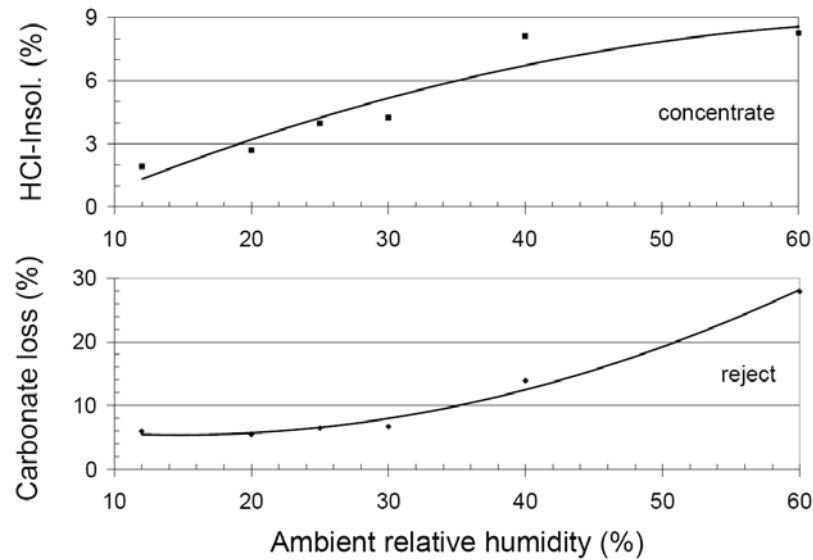

Figure 5-13: Insolubles grade and recovery in reject versus ambient humidity

<sup>57</sup> N.N., 1986, 3-5, 26-27



**Figure 5-14:** Concentrate insolubles grade and carbonate loss in reject versus ambient humidity

Additionally, measurements of the electrical resistance were carried out on the feed sample as a function of the ambient relative humidity. Therefore, 13g of the mineral sample were heated to 80°C and introduced into a cylindrical measurement device as depicted in Figure 5-16, which consists of a Teflon tube (1) with a conducting base plate (3), in which a cylindrical steel body (2) is inserted. The resistance/conductance of the sample (4) is determined by applying an electrical voltage on the steel cylinder and measuring the occurring current.

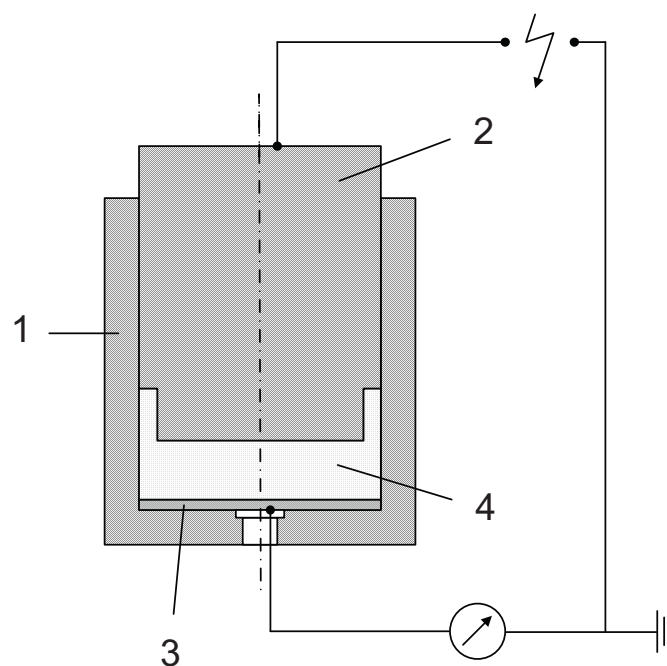

**Figure 5-15:** Schematic illustration of electrical resistance measurement device<sup>58</sup>

<sup>58</sup> Lindenthal, G., 1991, 109-111

Figure 5-16 shows a plot of the isolation conductance (= reciprocal of the isolation resistance) at different ambient humidities. The data set is quite consistent with the relation stated in Equation (2-15).

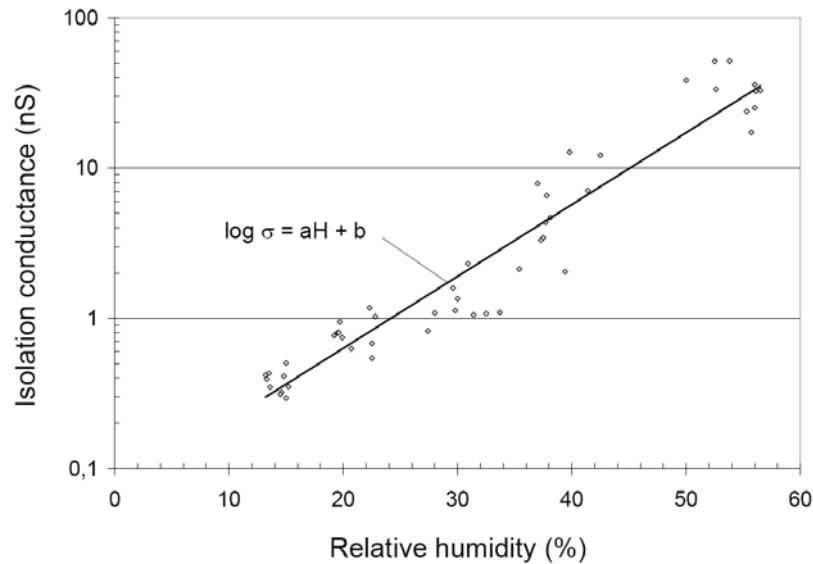

**Figure 5-16:** Isolation conductance versus relative humidity

The discharge behaviour of the bulk material is mainly determined by the *relaxation time constant*  $\tau$ <sup>59</sup>

$$\tau = \frac{\varepsilon}{\sigma} \quad (5-1)$$

where

$\varepsilon$  is the dielectric constant and

$\sigma$  is the conductivity of the mineral sample.

Accordingly, the time required for discharge decreases when the humidity is increased. So, mineral particles tend to lose their acquired charge slower when separation takes place in dry atmosphere.

<sup>59</sup> Hendricks, C.D., 1973, 24-28

### 5.2.5. Feed Moisture

(Test Numbers 26 – 31)

To observe the influence of water on the mineral surface, the moisture content of the feed sample was increased from <0.1wt% to 5wt%. The results demonstrate that electrostatic beneficiation is decisively hampered when the moisture content is elevated. Above 0.1% moisture, no separation was obtained at all. Therefore, the necessity for dry feed seems to be obvious to allow successful implementation of electrostatic separation.

### 5.2.6. Fines Content

(Test Numbers 14 – 19)

As stated in subsection 2.4.1, increasing amounts of fines create certain difficulties in conventional electrostatic separation. To quantify the extent of separation efficiency impairment, the percentage passing 0,063mm was raised from <2% to the maximum manageable with the present apparatus, 30%. A sub-sample of the initial feed was ground in a laboratory pin disc mill at 30Hz and subsequently subjected to hand sieve analysis. Specified amounts of the ground sample were admixed to the original feed to prepare mixtures containing desired fines contents. The calculated particle size distributions of the blended samples are shown in Figure 5-17.

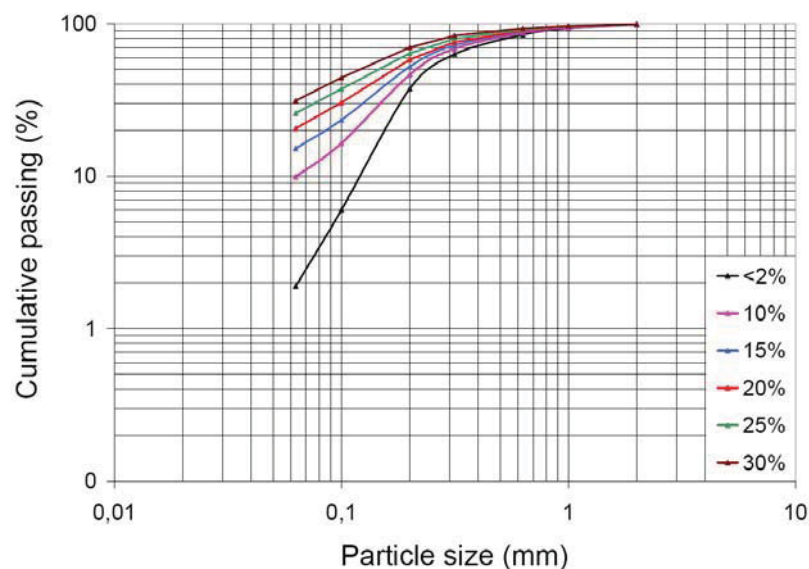

Figure 5-17: Calculated particle size distributions of prepared mixtures

As to be expected, the selectivity of the electrostatic separation dropped with increasing fines content. Both insolubles grade and recovery in the reject decreased raising the amount of fines in feed (Figure 5-18). Thereby, product quality (insolubles grade of concentrate) and valuable



losses downgraded as depicted in Figure 5-19. However, it is worth mentioning that the decline in separation performance is rather continuous than abrupt. Acceptable results were achieved when the amount  $<0,063\text{mm}$  did not exceed 10%.

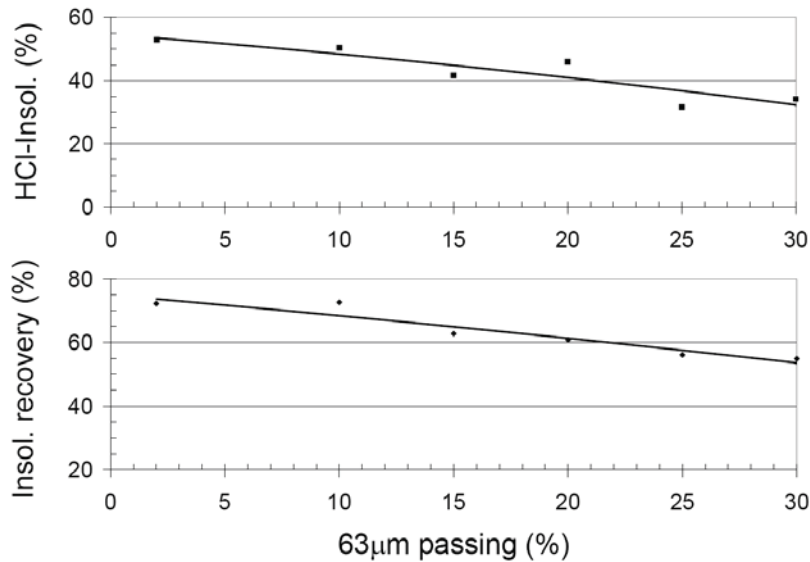

Figure 5-18: Insolubles grade and recovery in reject versus fines content

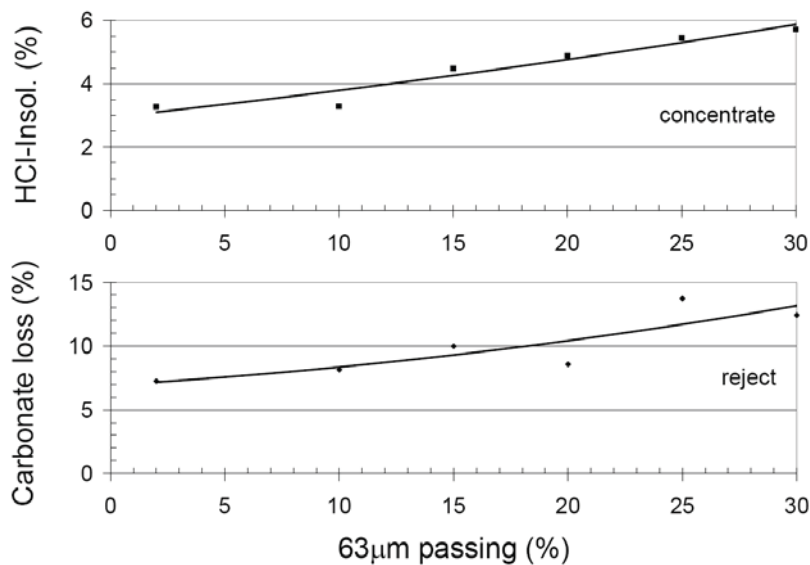

Figure 5-19: Concentrate insolubles grade and carbonate loss in reject versus fines content

### 5.2.7. Vibratory Feeder Temperature

(Test Numbers 32 – 36)

As stated earlier, the charge transfer is determined by the energetic structures of both mineral particles and tribocharging medium, which alter when the temperature is varied.<sup>60</sup>

<sup>60</sup> Manouchehri, H.R., 2000, 252

Consequently, a change in the temperature of the tribocharging medium may have considerable effect on polarity and magnitude of the imparted charges. To substantiate this allegation, the temperature of the vibratory feeder was elevated from room temperature (40°C) up to 150°C. The Figures 5-21 and 5-22 demonstrate that separation remains almost constant above 80°C. Below that temperature, the separation performance drops as insolubles grade and recovery in the positive electrode product decrease notably.

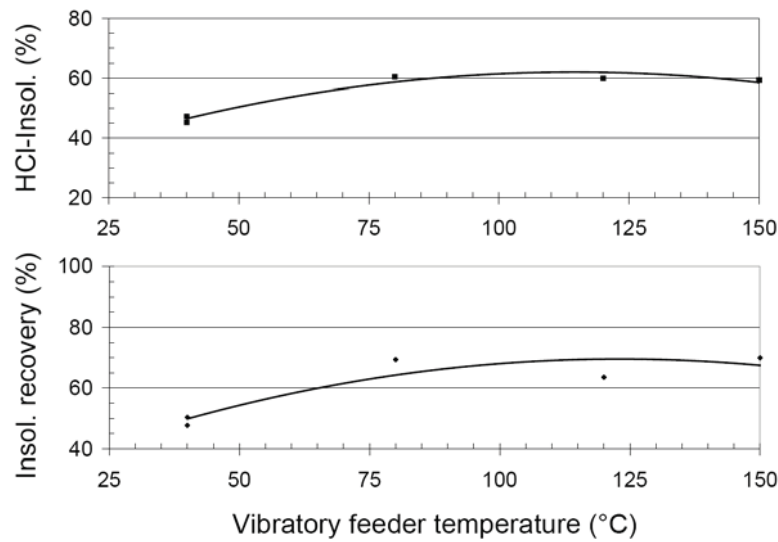

Figure 5-20: Insolubles grade and recovery in reject versus vibratory feeder temperature

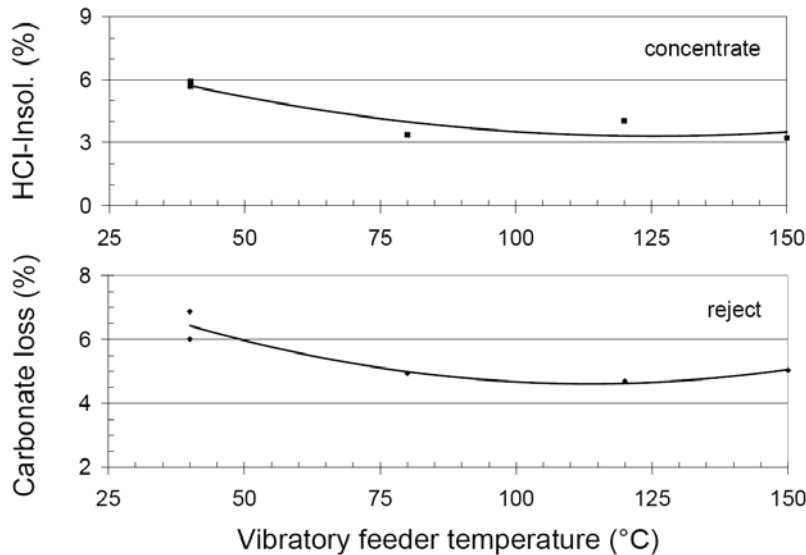

Figure 5-21: Concentrate insolubles grade and carbonate loss in reject versus vibratory feeder temperature

### 5.3. Multistage Separation

(Test Numbers 47; 47-1 – 47-3)

Multistage separation tests were conducted for the characterised marble sample to determine the achievable separation improvement by re-cleaning of products from the first separation stage. Analogous to flotation processes, electrostatic separation can also be operated in a multistage separation in the form of rougher, cleaner and scavenger stages.

The 10% HCl-insolubles feed sample was passed through the separator to produce a negative electrode fraction, middlings and a positive electrode fraction. Under equal conditions, each of the initial fractions was re-passed through the electrostatic separator. The weight and composition of the attained fractions is given in Table 5-1. The responding cumulative mass versus cumulative insolubles grade curve is depicted in Figure 5-22.

By re-cleaning only the middlings as shown in Figure 5-23, a 98.3% carbonate (1.7% insolubles) concentrate was obtained, with a mass recovery of 82.7%. In comparison, the product of the one-stage separation contained 95.7% carbonate (4.3% insolubles) and represented 88.5% of the feed weight. A still better separation result may be achieved by optimising the splitter position for the cleaning of the first stage's middlings.

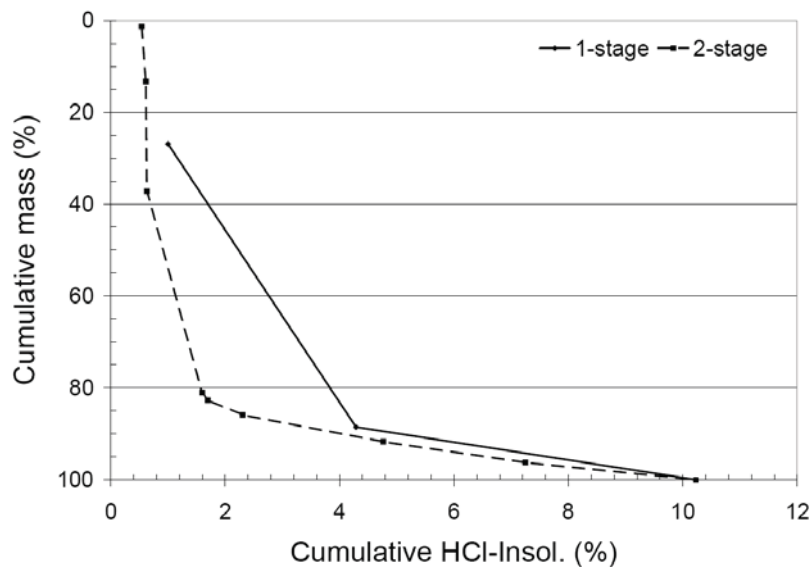

Figure 5-22: Cumulative mass versus cumulative insolubles grade curve

Stage 1	Mass (%)	HCl-Insol.		Stage 2	Mass (%)	HCl-Insol.		Carbonate	
		(%)	Recovery (%)			(%)	Recovery (%)	(%)	Recovery (%)
N	26,89	1,00	2,63	NN	5,04	0,54	2,72	99,46	5,06
				NC	88,72	0,64	56,69	99,36	89,04
				NP	6,24	6,51	40,59	93,49	5,90
				Total	100,00	1,00	100,00	99,00	100,00
C	61,64	5,72	34,47	CN	19,41	0,62	2,10	99,38	20,46
				CC	71,12	2,42	30,09	97,58	73,61
				CP	9,47	40,94	67,81	59,06	5,93
				Total	100,00	5,72	100,00	94,28	100,00
P	11,47	56,08	62,90	PN	27,94	17,96	8,95	82,04	52,18
				PC	39,44	57,60	40,51	42,40	38,08
				PP	32,62	86,89	50,54	13,11	9,74
				Total	100,00	56,08	100,00	43,92	100,00
Feed	100,00	10,23	100,00						

Table 5-1: 2-stage electrostatic separation results

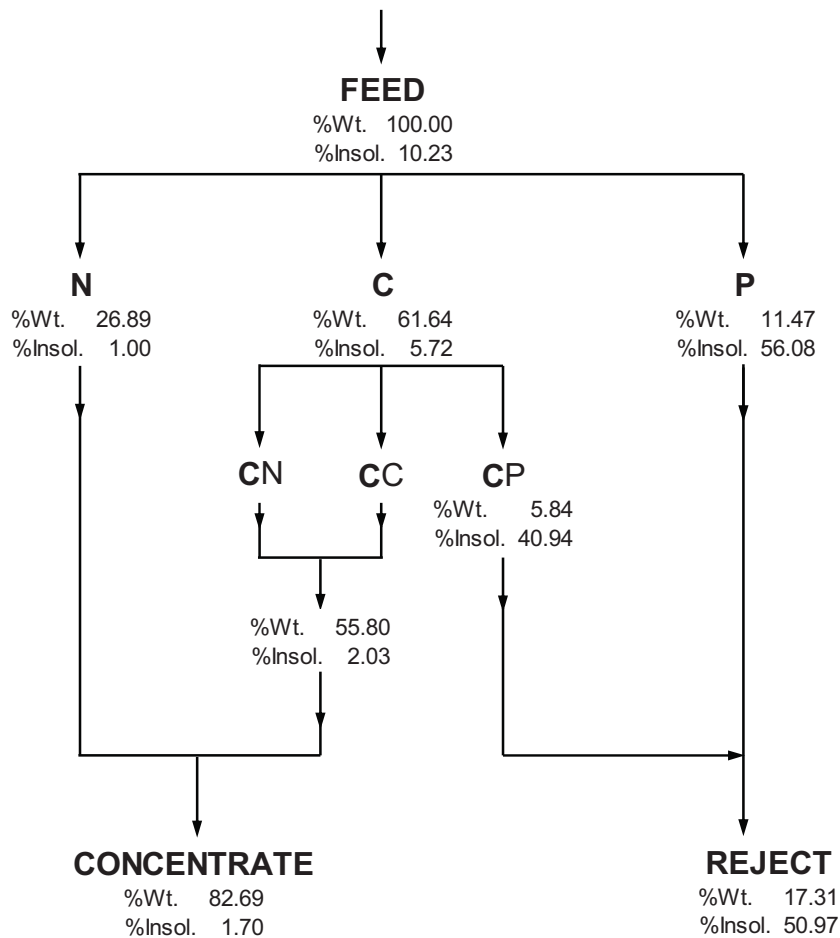

Figure 5-23: Schematic flowsheet of 2-stage electrostatic separation

## 5.4. Extensive Analysis of Separation Products

### 5.4.1. Partition Numbers

To gather information about the dependence of electrostatic separation selectivity on the particle size, the products of an average separation test were subjected to hand sieve analysis, the size fractions then analysed regarding their amount of HCl-insoluble residue.

Then, partition numbers  $PN_{k,i,j}$  were calculated to characterise the performance of the electrostatic separation in the size fractions  $k$  of the products  $j$ :

$$PN_{k,i,j} = r_{mj} \cdot \frac{m_{k,j} \cdot a_{k,i,j}}{m_{k,0} \cdot a_{k,i,0}} \quad (5-2)$$

where

$r_{mj}$  is the recovery of mass  $r_m$  in the product  $j$  ( $j=0$ : feed;  $j=1$ : Negative;  $j=2$ : Center;  $j=3$ : Positive),

$m_{k,j}$  is the mass  $m$  of size fraction  $k$  in product  $j$  and

$a_{k,i,j}$  is the grade  $a$  of component  $i$  ( $i=1$ : insolubles;  $i=2$ : carbonate) in fraction  $k$  of product  $j$ .

Mass, assay and partition number of each size fractions are summarised in Table 5-2. Figure 5-24 shows the reject's (= positive electrode product) partition number regarding HCl-insolubles as a function of the particle size.

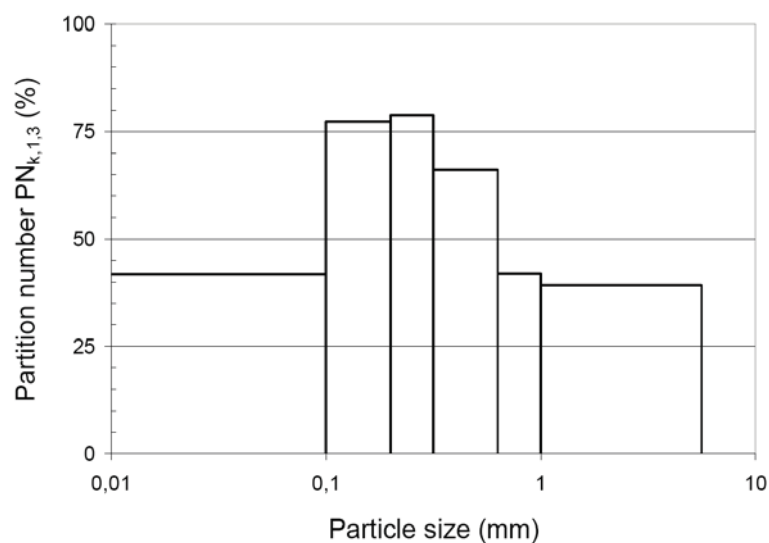

**Figure 5-24:** Partition numbers of electrostatic separation

It is worth annotating that

- the size fractions 0.630/0.315mm, 0.315/0.200mm and 0.200/0.100mm, which contain the highest amounts of HCl-insolubles and represent 83.5% of the overall mass, show the best partition numbers  $PN_{k,1,3}$ . Apparently, the ratio of the co-acting forces is optimum in these size fractions containing the most impurities.
- more than 16% of the HCl-insolubles present in the particle size range <0.100mm were converted into the negative electrode product. It seems to be confirmed that the fluid friction component predominates so that the mineral particles are not free falling. Additionally, the finest particles are not optimally charged in the vibratory feeder and precharging shaft.

Index k	Size fraction (mm)	NEGATIVE ELECTRODE PRODUCT (j=1) $r_{m1} = 34,01$ %			CENTER (j=2) $r_{m2} = 53,73$ %			POSITIVE ELECTRODE PRODUCT (j=3) $r_{m3} = 12,26$ %			FEED (j=0) $r_{mo} = 100,00$ %		
		Mass (%)	HCl-Insol. (%)	PN <sub>k,1,1</sub> (%)	Mass (%)	HCl-Insol. (%)	PN <sub>k,1,2</sub> (%)	Mass (%)	HCl-Insol. (%)	PN <sub>k,1,3</sub> (%)	Mass (%)	HCl-Insol. (%)	PN <sub>k,1,0</sub> (%)
1	1	1,75	2,14	7,9	5,33	2,99	52,8	8,72	5,95	39,3	4,53	3,58	100,0
2	0,630	2,84	1,50	5,3	10,36	2,62	52,9	5,06	18,58	41,8	7,15	3,85	100,0
3	0,315	13,59	0,64	1,8	29,45	3,26	32,0	15,05	57,74	66,2	22,29	7,23	100,0
4	0,200	28,04	0,57	1,3	24,02	6,37	19,8	33,04	80,66	78,9	26,49	15,64	100,0
5	0,100	46,92	0,66	2,7	27,00	5,38	20,0	35,10	70,13	77,3	34,77	11,23	100,0
6	0	6,86	1,03	16,3	3,84	3,00	41,9	3,03	16,58	41,8	4,77	3,09	100,0
0	Total	100,00	0,71	-	100,00	4,49	-	100,00	61,92	-	100,00	10,24	-

Table 5-2: Analysis of separation performance by means of partition numbers

### 5.4.2. Slurry Grinding

Selected calcium carbonate products from electrostatic separation testing were subjected to brightness and yellowness analysis according to ISO 2469 and DIN 6167, respectively, and compared to a flotation concentrate from the mineral processing plant in Canada. The chosen products obtained by electrostatic beneficiation contained approximately 2% and 3% HCl-insolubles, respectively. Prior to analysis, the samples were wet ground to 50%<2 $\mu$ m and 80%<2 $\mu$ m in a ceramic laboratory mill (Dynomill). The results are shown in Table 5-3.

Designation	HCl-Insol. (%)	Fineness	Yellowness index	Brightness (Tappi R457)
Electrostatic Separation Feed	10	50%<2 $\mu$ m	0.9	93.5
		80%<2 $\mu$ m	0.4	92.8
Electrostatic Separation Concentrate 1	2.05	50%<2 $\mu$ m	0.8	94.9
		80%<2 $\mu$ m	0.5	94.4
Electrostatic Separation Concentrate 2	2.92	50%<2 $\mu$ m	0.9	94.4
		80%<2 $\mu$ m	0.6	94.0
Flotation Concentrate	1.10	50%<2 $\mu$ m	0.7	94.6
		80%<2 $\mu$ m	0.6	93.8

**Table 5-3:** Brightness and yellowness measurement of electrostatic separation concentrates

Although containing considerably more HCl-insoluble residue, electrostatic separation concentrates show almost equal (3% insolubles) or even higher (2%) degrees of brightness in comparison to the flotation product. So, it must be assumed that the outweighing amount of colouring impurities (most notably sulfides) has been removed from the concentrate by electrostatic beneficiation. A part of the brightness difference can also result from the fact that the electrostatic separation concentrates were wet-ground in a ceramic lined lab mill, whereas the brightness data of the flotation product originates from a full-scale production mill. Thus, also machine wear may cause some brightness deterioration by grinding of high HCl-insoluble carbonate concentrates.



## 6. Outlook and Discussion

Triboelectrostatic separation is the physical sorting of solid mixtures by utilising inherent differences in the electrical properties of the mineral surfaces. Being a dry beneficiation method, it circumvents undesirable attendant circumstances that are inseparably associated to wet processing operations, e.g. maintenance of a costly water circuit, utilisation of process chemicals, contamination of carbonate concentrates with flotation agents, drying of concentrates for the production of powder products, etc.

Unfortunately, charge acquisition by triboelectrification or contact charging is far from being fully understood. The complexity of tribo/contact charging must be primarily attributed to the variety and diversity of processes taking place concurrently. However, calcite and its accompanying siliceous components differ so little in specific gravity, optical appearance and magnetic susceptibility so that all other dry sorting methods are obviously ruled out.

The following conclusions can be drawn from the present study aimed at investigating the parameters affecting the triboelectric beneficiation of calcium carbonate raw materials:

- The results of some separation tests conducted in virtually the same circumstances vary to a considerable extent. This matter of fact may be dedicated to the long storage time of the feed samples, which might have caused alterations of the mineral surfaces and subsequently in the electrical surface properties.
- Electrostatic separation proved to be a proper method for dry sorting of calcium carbonate from siliceous and colouring constituents. Under appropriate operating conditions in either single or multi stage separations, concentrates with low amount of impurities and high brightness were obtained, with acceptable losses of valuable mineral in the reject.
- Feed material containing moisture or high amounts of fines is not suitable for being concentrated by the electrostatic method in a free-fall separator. Furthermore, the best separation results were achieved in dry atmosphere when the sample was heated above 80°C. Separation performance also increases gradually when the feed rate is decreased.

- Charge generation itself could be altered by shifting the Fermi levels of the contacting partners by either applying an additional electric field (precharging) or elevating the tribocharger (= vibratory feeder) temperature.
- Fortunately, the size fractions containing the highest amount of impurities (0.630/0.100mm), which represent the vast majority of the overall mass, respond best to electrostatic beneficiation. Particles below 0.100mm and above 1mm cause difficulties and systematically depress separation performance.

Based on the results obtained hitherto, the prospects for the successful industrial application of triboelectrostatic separation are promising. Nevertheless, the research is far from being concluded. Further investigations have to be conducted to estimate the effect of alternative tribocharging media and devices on the charging mechanism. Insulator materials (Perspex, Teflon, ceramic) may minimise the charge backflow by conduction or corona discharge and thereby impart greater charges on the mineral surface than copper or stainless steel. Moreover, studies suggest that continuous sliding motion (as is the case on an inclined chute) is a more proper type of triboelectrification than rolling or vibration transport for minerals that come under the insulator ore semiconductor category.<sup>61</sup>

However, the present paper provides a thorough support for the up-scaling of commercial full-scale electrostatic separation equipment. The major operating parameters have been monitored to evaluate their extent of influence on both charge acquisition and behaviour of the charged particles in an applied electric field.

---

<sup>61</sup> Ciccu, R. et al.,1989, 164-168

## REFERENCES

Beblo, M.: Electrical Properties. In: Landolt-Börnstein Numerical data and functional relationships in science and technology (Editor: G. Angenheister), New series, Group V Geophysics and space research, Vol. 1 Physical properties of rocks, Subvol. B, Springer-Verlag, Berlin-Heidelberg-New York, 1982, 604

Bittner, J.D. and S.A. Gasiorowski: STI's six years of commercial experience in electrostatic beneficiation of fly ash. International Ash Utilization Symposium, Center for Applied Energy Research, University of Kentucky, Paper 16

Chang, J., A.J. Kelly and J.M. Crowley: Handbook of electrostatic processes. Marcel Dekker Publishers Inc., New York, 1995, 763

Ciccu, R., R. Peretti, A. Serici, M. Tamanini and A. Zucca: Experimental study on triboelectric charging of mineral particles. Journal of Electrostatics, 23, 1989, 157-168

Dodbiba, G., A. Shibayama, T. Miyazaki and T. Fujita: Electrostatic separation of the shredded plastic mixtures using a tribo-cyclone. Magnetic and Electrical Separation, Vol. 11/1-2, 2002, 63-92

Fraas, F.: Electrostatic separation of granular materials. U.S. Department of the Interior, Bureau of Mines, Bulletin 603, 1962, 155

Fricke, H., H. Frohne and P. Vaske: Grundlagen der Elektrotechnik. 16. Aufl., B.G. Teubner, Stuttgart, 1976, 548

Hangsubcharoen, M., E.S. Yan, R.-H. Yoon and G.H. Luttrell: Evaluation of the charging characteristics of particles in triboelectrostatic separation. SME Annual Meeting, Salt Lake City, Preprint No. 00-156, 2000, 1-6

Hendricks, C.D.: Introduction to electrostatics. University of Illinois, 1973

Holleman, A.F. and E. Wiberg: Lehrbuch der anorganische Chemie. 91.-100. Aufl., de Gruyter, Berlin-New York, 1985, 1451

Inculet, I.I. and M.A. Bergougnou: Electrostatic beneficiation of fine mineral particles in a fluidized bed. Proceedings of Tenth Mineral Processing Congress, London, Paper 11, 1973, 377-390

Keller, G.V.: Electrical Properties. In: Practical handbook of physical properties of rocks and minerals (Editor: R.S. Carmichael), Section V, CRC Press, Boca Raton-Ann Arbor-Boston, 1989, 741

Kelly, E.G. and D.J. Spottiswood: Introduction to mineral processing. 1. edition, [2.] reprint., Australian Mineral Foundation, 1995, 491

Kim, J.-K. and S.-C. Kim: Tribo-electrostatic beneficiation of fly ash for ash utilization. Korean Journal of Chemical Engineering, Vol. 18/4, 2001, 531-538

Kumar, K.K. and L. Sirdeshmukh: Dielectric properties and electrical conductivity studies on some minerals. Indian Journal of Pure and Applied Physics, Vol. 34, 1996, 559-565

Lee, J.-K. and J.-H. Shin: Design and performance evaluation of triboelectrostatic separation system for the separation of PVC and PET materials using a fluidized bed tribocharger. Korean Journal of Chemical Engineering, Vol. 20/3, 2003, 572-579

Lindenthal, G.: Klassierung feindisperser Feststoffe im Zentrifugalfeld mit überlagertem elektrischem Feld bei Trenngrenzen um 1 $\mu$ m. Dissertation, Technische Universität Clausthal, Fakultät für Bergbau, Hüttenwesen und Maschinenwesen, 1991, 187

Manouchehri, H.R.: Triboelectric charge characteristics and electrical separation of industrial minerals. Doctoral Thesis, Lulea University of Technology, Dept. of Chemical and Metallurgical Engineering, Division of Mineral Processing, 2000, 271

Manouchehri, H.R., K. Hanumantha Rao and K.S.E. Forssberg: Triboelectric charge, electrophysical properties and electrical beneficiation potential of chemically treated feldspar, quartz and wollastonite. *Magnetic and Electrical Separation*, Vol. 11/1-2, 2002, 9-32

N.N.: Optimierung und Grenzen der elektrostatischen Sortierung durch bipolare Aufladung von Mineralgemischen im Feinkornbereich. Technische Universität Clausthal, Institut für Aufbereitung und Veredelung, Forschungsprojekt 03 R 078, Zwischenbericht 1986

Pearse, M.J. and M.I. Pope: The separation of quartz-dolomite powders using a triboelectric technique. *Powder Technology*, Vol. 14, 1976, 7-15

Pearse, M.J. and M.I. Pope: The triboelectric separation of quartz-calcite and quartz-apatite powders after chemical conditioning, *Powder Technology*, Vol. 17, 1977, 83-89

Schein, L.B.: The charging of insulator surfaces. *Journal of Electrostatics*, Vol. 51-52, 2001, 82-90

Schein, L.B.: Electric field theory of toner charging. *Journal of imaging science and technology*, Vol. 44/6, 2000, 475-483

Schein, L.B., M. LaHa and D. Novotny: Theory of insulator charging. *Physics Letters A* 167, 1992, 79-83

Schön, J.H.: Physical properties of rocks: fundamentals and principles of petrophysics. In: *Handbook of geophysical exploration, Section I: Seismic exploration* (Editors: K. Helbig and S. Treitel), Vol. 18, Pergamon Press, Oxford, 1996, 583

Schubert, H.: *Aufbereitung fester Stoffe, Band II: Sortierprozesse*. 4. Aufl., Verlag für Grundstoffindustrie, Stuttgart, 1996, 540

Soong, Y., T.A. Link, M.R. Schoffstall, L. Turčániová, P. Baláž, S. Marchant and R.R. Schehl: Triboelectrostatic Separation of mineral matter from Slovakian coals. *Acta Montanistica Slovaca, Ročník 3*, 1998, 393-400

Whitlock, D., A. Vasiliauskas, J. Bittner and E. Tondu: Dry electrostatic separation of fine powders – A revolutionary approach to processing minerals. Processing for Profit, Industrial Minerals Conference, Amsterdam, Session 3, Paper 1, 1995

Yoon R.-H., G.H. Luttrell, E.S. Yan and A.D. Walters: POC-scale testing of a dry tribo-electrostatic separator for fine coal cleaning. Final technical report, Virginia Polytechnic Institute and State University, Center for Coal and Minerals Processing, 2001, 235

# APPENDIX

# ELECTROSTATIC SEPARATION TESTING

## Test Report

Test-N°: **1**

Date: 12.04.2006

Test series:

**Feed Rate**

Nominal Throughput

**0,25**

[kg/ms]

<b>Feed:</b>	Input mass:	<u>9350</u> [g]	Temperature:	<u>80</u> [°]
	Time:	<u>143</u> [s]	Moisture:	<u>&lt; 0,1</u> [%]
	Throughput:	<u>0,23</u> [kg/ms]	m <sub>&lt;63µm</sub> :	<u>&lt; 5</u> [%]

<b>Ambient air:</b>	Temperature:	<u>25</u> [°C]	Rel. humidity:	<u>25</u> [%]
<b>Separation Chamber:</b>	Temperature:	<u>40-44</u> [°C]	Rel. humidity:	<u>8-10</u> [%]

<b>Electrode settings:</b>	pos. (+) top:	<u>5</u> [%]	neg. (-) top:	<u>5</u> [%]
	pos. (+) bottom:	<u>45</u> [%]	neg. (-) bottom:	<u>45</u> [%]

<b>Electrode voltage:</b>	pos. (+):	<u>30,0<sup>1</sup>(31,3<sup>2</sup>)</u> [kV]	neg. (-):	<u>-30,0<sup>1</sup>(-31,7<sup>2</sup>)</u> [kV]
---------------------------	-----------	--	-----------	--

<b>Splitter position:</b>	pos. (+):	<u>20</u> [%]	neg. (-):	<u>20</u> [%]
---------------------------	-----------	---------------	-----------	---------------

<b>Vibratory feeder:</b>	Level:	<u>3,0</u> [-]	Temperature:	<u>150</u> [°]
	Gap width:	<u>5</u> [mm]	Material:	<u>Steel</u>

<b>Feed hopper:</b>	Temperature:	<u>100</u> [°C]
---------------------	--------------	-----------------

<b>Shaker:</b>	Shaft:	<u>ON</u> / OFF	Electrodes:	<u>ON</u> / OFF
----------------	--------	-----------------	-------------	-----------------

<b>Mass of products:</b>	(+) electrode (P):	<u>1410,3</u> [g]
	Middlings (C):	<u>1804,0</u> [g]
	(-) electrode (N):	<u>6014,3</u> [g]
	<b>Sum (N+C+P):</b>	<u>9228,6</u> [g]

**Annotations:** <sup>1</sup> Effective voltage on electrodes (tapped with multimeter)

<sup>2</sup> Nominal voltage (on DC generator display)



# ELECTROSTATIC SEPARATION TESTING

## Test Report

Test-N°: **2**

Date: 12.04.2006

Test series:

**Feed Rate**

Nominal Throughput **0,50** [kg/ms]

<b>Feed:</b>	Input mass:	<u>9350</u> [g]	Temperature:	<u>80</u> [°]
	Time:	<u>69,0</u> [s]	Moisture:	<u>&lt; 0,1</u> [%]
	Throughput:	<u>0,47</u> [kg/ms]	m <sub>&lt;63µm</sub> :	<u>&lt; 5</u> [%]

<b>Ambient air:</b>	Temperature:	<u>25</u> [°C]	Rel. humidity:	<u>25</u> [%]
<b>Separation Chamber:</b>	Temperature:	<u>40-44</u> [°C]	Rel. humidity:	<u>8-10</u> [%]

<b>Electrode settings:</b>	pos. (+) top:	<u>5</u> [%]	neg. (-) top:	<u>5</u> [%]
	pos. (+) bottom:	<u>45</u> [%]	neg. (-) bottom:	<u>45</u> [%]

<b>Electrode voltage:</b>	pos. (+):	<u>30,0<sup>1</sup>(31,3<sup>2</sup>)</u> [kV]	neg. (-):	<u>-30,0<sup>1</sup>(-31,7<sup>2</sup>)</u> [kV]
---------------------------	-----------	--	-----------	--

<b>Splitter position:</b>	pos. (+):	<u>20</u> [%]	neg. (-):	<u>20</u> [%]
---------------------------	-----------	---------------	-----------	---------------

<b>Vibratory feeder:</b>	Level:	<u>4,5</u> [-]	Temperature:	<u>150</u> [°]
	Gap width:	<u>5</u> [mm]	Material:	<u>Steel</u>

<b>Feed hopper:</b>	Temperature:	<u>100</u> [°C]
---------------------	--------------	-----------------

<b>Shaker:</b>	Shaft:	<b>ON</b> / OFF	Electrodes:	<b>ON</b> / OFF
----------------	--------	-----------------	-------------	-----------------

<b>Mass of products:</b>	(+) electrode (P):	<u>1273,2</u> [g]
	Middlings (C):	<u>2302,4</u> [g]
	(-) electrode (N):	<u>5652,2</u> [g]
	<b>Sum (N+C+P):</b>	<b><u>9227,8</u> [g]</b>

**Annotations:**

<sup>1</sup> Effective voltage on electrodes (tapped with multimeter)

<sup>2</sup> Nominal voltage (on DC generator display)

# ELECTROSTATIC SEPARATION TESTING

## Test Report

Test-N°: **3**

Date: 13.04.2006

Test series:

**Feed Rate**

Nominal Throughput **1,0** [kg/ms]

<b>Feed:</b>	Input mass:	<u>9350</u> [g]	Temperature:	<u>80</u> [°]
	Time:	<u>36,0</u> [s]	Moisture:	<u>&lt; 0,1</u> [%]
	Throughput:	<u>0,90</u> [kg/ms]	m <sub>&lt;63µm</sub> :	<u>&lt; 5</u> [%]

<b>Ambient air:</b>	Temperature:	<u>25</u> [°C]	Rel. humidity:	<u>25</u> [%]
<b>Separation Chamber:</b>	Temperature:	<u>40-44</u> [°C]	Rel. humidity:	<u>8-10</u> [%]

<b>Electrode settings:</b>	pos. (+) top:	<u>5</u> [%]	neg. (-) top:	<u>5</u> [%]
	pos. (+) bottom:	<u>45</u> [%]	neg. (-) bottom:	<u>45</u> [%]

<b>Electrode voltage:</b>	pos. (+):	<u>30,0<sup>1</sup>(31,3<sup>2</sup>)</u> [kV]	neg. (-):	<u>-30,0<sup>1</sup>(-31,7<sup>2</sup>)</u> [kV]
---------------------------	-----------	--	-----------	--

<b>Splitter position:</b>	pos. (+):	<u>20</u> [%]	neg. (-):	<u>20</u> [%]
---------------------------	-----------	---------------	-----------	---------------

<b>Vibratory feeder:</b>	Level:	<u>5,5</u> [-]	Temperature:	<u>150</u> [°]
	Gap width:	<u>5</u> [mm]	Material:	<u>Steel</u>

<b>Feed hopper:</b>	Temperature:	<u>100</u> [°C]
---------------------	--------------	-----------------

<b>Shaker:</b>	Shaft:	<u>ON</u> / OFF	Electrodes:	<u>ON</u> / OFF
----------------	--------	-----------------	-------------	-----------------

<b>Mass of products:</b>	(+) electrode (P):	<u>1267,9</u> [g]
	Middlings (C):	<u>3660,9</u> [g]
	(-) electrode (N):	<u>4288,6</u> [g]
	<b>Sum (N+C+P):</b>	<u>9217,4</u> [g]

**Annotations:**

<sup>1</sup> Effective voltage on electrodes (tapped with multimeter)

<sup>2</sup> Nominal voltage (on DC generator display)

# ELECTROSTATIC SEPARATION TESTING

## Test Report

Test-N°: **4**

Date: 13.04.2006

Test series:

**Feed Rate**

Nominal Throughput **1,0** [kg/ms]

<b>Feed:</b>	Input mass:	<u>9350</u> [g]	Temperature:	<u>80</u> [°]
	Time:	<u>32,2</u> [s]	Moisture:	<u>&lt; 0,1</u> [%]
	Throughput:	<u>1,00</u> [kg/ms]	m <sub>&lt;63µm</sub> :	<u>&lt; 5</u> [%]

<b>Ambient air:</b>	Temperature:	<u>25</u> [°C]	Rel. humidity:	<u>25</u> [%]
<b>Separation Chamber:</b>	Temperature:	<u>40-44</u> [°C]	Rel. humidity:	<u>8-10</u> [%]

<b>Electrode settings:</b>	pos. (+) top:	<u>5</u> [%]	neg. (-) top:	<u>5</u> [%]
	pos. (+) bottom:	<u>45</u> [%]	neg. (-) bottom:	<u>45</u> [%]

<b>Electrode voltage:</b>	pos. (+):	<u>30,0<sup>1</sup>(31,3<sup>2</sup>)</u> [kV]	neg. (-):	<u>-30,0<sup>1</sup>(-31,7<sup>2</sup>)</u> [kV]
---------------------------	-----------	--	-----------	--

<b>Splitter position:</b>	pos. (+):	<u>20</u> [%]	neg. (-):	<u>20</u> [%]
---------------------------	-----------	---------------	-----------	---------------

<b>Vibratory feeder:</b>	Level:	<u>6,1</u> [-]	Temperature:	<u>150</u> [°]
	Gap width:	<u>5</u> [mm]	Material:	<u>Steel</u>

<b>Feed hopper:</b>	Temperature:	<u>100</u> [°C]
---------------------	--------------	-----------------

<b>Shaker:</b>	Shaft:	<u>ON</u> / OFF	Electrodes:	<u>ON</u> / OFF
----------------	--------	-----------------	-------------	-----------------

<b>Mass of products:</b>	(+) electrode (P):	<u>1215,1</u> [g]
	Middlings (C):	<u>4136,6</u> [g]
	(-) electrode (N):	<u>3862,7</u> [g]
	<b>Sum (N+C+P):</b>	<u>9214,4</u> [g]

**Annotations:**

<sup>1</sup> Effective voltage on electrodes (tapped with multimeter)

<sup>2</sup> Nominal voltage (on DC generator display)

# ELECTROSTATIC SEPARATION TESTING

## Test Report

Test-N°: **5**

Date: 13.04.2006

Test series:

**Feed Rate**

Nominal Throughput **1,5** [kg/ms]

<b>Feed:</b>	Input mass:	<u>9350</u> [g]	Temperature:	<u>80</u> [°]
	Time:	<u>22,5</u> [s]	Moisture:	<u>&lt; 0,1</u> [%]
	Throughput:	<u>1,43</u> [kg/ms]	m <sub>&lt;63µm</sub> :	<u>&lt; 5</u> [%]

<b>Ambient air:</b>	Temperature:	<u>25</u> [°C]	Rel. humidity:	<u>25</u> [%]
<b>Separation Chamber:</b>	Temperature:	<u>40-44</u> [°C]	Rel. humidity:	<u>8-10</u> [%]

<b>Electrode settings:</b>	pos. (+) top:	<u>5</u> [%]	neg. (-) top:	<u>5</u> [%]
	pos. (+) bottom:	<u>45</u> [%]	neg. (-) bottom:	<u>45</u> [%]

<b>Electrode voltage:</b>	pos. (+):	<u>30,0<sup>1</sup>(31,3<sup>2</sup>)</u> [kV]	neg. (-):	<u>-30,0<sup>1</sup>(-31,7<sup>2</sup>)</u> [kV]
---------------------------	-----------	--	-----------	--

<b>Splitter position:</b>	pos. (+):	<u>20</u> [%]	neg. (-):	<u>20</u> [%]
---------------------------	-----------	---------------	-----------	---------------

<b>Vibratory feeder:</b>	Level:	<u>4,5</u> [-]	Temperature:	<u>150</u> [°]
	Gap width:	<u>10</u> [mm]	Material:	<u>Steel</u>

<b>Feed hopper:</b>	Temperature:	<u>100</u> [°C]
---------------------	--------------	-----------------

<b>Shaker:</b>	Shaft:	<u>ON</u> / OFF	Electrodes:	<u>ON</u> / OFF
----------------	--------	-----------------	-------------	-----------------

<b>Mass of products:</b>	(+) electrode (P):	<u>1143,9</u> [g]
	Middlings (C):	<u>5081,1</u> [g]
	(-) electrode (N):	<u>2976,4</u> [g]
	<b>Sum (N+C+P):</b>	<u>9201,4</u> [g]

**Annotations:**

<sup>1</sup> Effective voltage on electrodes (tapped with multimeter)

<sup>2</sup> Nominal voltage (on DC generator display)

# ELECTROSTATIC SEPARATION TESTING

## Test Report

Test-N°: **6**

Date: 18.04.2006

Test series:

**Feed Rate**

Nominal Throughput **2,0** [kg/ms]

<b>Feed:</b>	Input mass:	<u>9350</u> [g]	Temperature:	<u>80</u> [°]
	Time:	<u>15,5</u> [s]	Moisture:	<u>&lt; 0,1</u> [%]
	Throughput:	<u>2,08</u> [kg/ms]	m <sub>&lt;63µm</sub> :	<u>&lt; 5</u> [%]

<b>Ambient air:</b>	Temperature:	<u>25</u> [°C]	Rel. humidity:	<u>28</u> [%]
<b>Separation Chamber:</b>	Temperature:	<u>40-44</u> [°C]	Rel. humidity:	<u>8-10</u> [%]

<b>Electrode settings:</b>	pos. (+) top:	<u>5</u> [%]	neg. (-) top:	<u>5</u> [%]
	pos. (+) bottom:	<u>45</u> [%]	neg. (-) bottom:	<u>45</u> [%]

<b>Electrode voltage:</b>	pos. (+):	<u>30,0<sup>1</sup>(31,3<sup>2</sup>)</u> [kV]	neg. (-):	<u>-30,0<sup>1</sup>(-31,7<sup>2</sup>)</u> [kV]
---------------------------	-----------	--	-----------	--

<b>Splitter position:</b>	pos. (+):	<u>20</u> [%]	neg. (-):	<u>20</u> [%]
---------------------------	-----------	---------------	-----------	---------------

<b>Vibratory feeder:</b>	Level:	<u>5,5</u> [-]	Temperature:	<u>150</u> [°]
	Gap width:	<u>10</u> [mm]	Material:	<u>Steel</u>

<b>Feed hopper:</b>	Temperature:	<u>100</u> [°C]
---------------------	--------------	-----------------

<b>Shaker:</b>	Shaft:	<u>ON</u> / OFF	Electrodes:	<u>ON</u> / OFF
----------------	--------	-----------------	-------------	-----------------

<b>Mass of products:</b>	(+) electrode (P):	<u>893,2</u> [g]
	Middlings (C):	<u>6657,7</u> [g]
	(-) electrode (N):	<u>1683,8</u> [g]
	<b>Sum (N+C+P):</b>	<u>9234,7</u> [g]

**Annotations:**

<sup>1</sup> Effective voltage on electrodes (tapped with multimeter)

<sup>2</sup> Nominal voltage (on DC generator display)

# ELECTROSTATIC SEPARATION TESTING

## Test Report

Test-N°: 7

Date: 18.04.2006

Test series:

**Feed Rate**

Nominal Throughput 2,5 [kg/ms]

<b>Feed:</b>	Input mass:	<u>9350</u> [g]	Temperature:	<u>80</u> [°]
	Time:	<u>13,5</u> [s]	Moisture:	<u>&lt; 0,1</u> [%]
	Throughput:	<u>2,39</u> [kg/ms]	m <sub>&lt;63µm</sub> :	<u>&lt; 5</u> [%]

<b>Ambient air:</b>	Temperature:	<u>25</u> [°C]	Rel. humidity:	<u>29</u> [%]
<b>Separation Chamber:</b>	Temperature:	<u>40-44</u> [°C]	Rel. humidity:	<u>8-10</u> [%]

<b>Electrode settings:</b>	pos. (+) top:	<u>5</u> [%]	neg. (-) top:	<u>5</u> [%]
	pos. (+) bottom:	<u>45</u> [%]	neg. (-) bottom:	<u>45</u> [%]

<b>Electrode voltage:</b>	pos. (+):	<u>30,0<sup>1</sup>(31,3<sup>2</sup>)</u> [kV]	neg. (-):	<u>-30,0<sup>1</sup>(-31,7<sup>2</sup>)</u> [kV]
---------------------------	-----------	--	-----------	--

<b>Splitter position:</b>	pos. (+):	<u>20</u> [%]	neg. (-):	<u>20</u> [%]
---------------------------	-----------	---------------	-----------	---------------

<b>Vibratory feeder:</b>	Level:	<u>6,2</u> [-]	Temperature:	<u>150</u> [°]
	Gap width:	<u>10</u> [mm]	Material:	<u>Steel</u>

<b>Feed hopper:</b>	Temperature:	<u>100</u> [°C]
---------------------	--------------	-----------------

<b>Shaker:</b>	Shaft:	<u>ON</u> / OFF	Electrodes:	<u>ON</u> / OFF
----------------	--------	-----------------	-------------	-----------------

<b>Mass of products:</b>	(+) electrode (P):	<u>763,7</u> [g]
	Middlings (C):	<u>6905,1</u> [g]
	(-) electrode (N):	<u>1524,5</u> [g]
	<b>Sum (N+C+P):</b>	<u>9193,3</u> [g]

**Annotations:**

<sup>1</sup> Effective voltage on electrodes (tapped with multimeter)

<sup>2</sup> Nominal voltage (on DC generator display)

# ELECTROSTATIC SEPARATION TESTING

## Test Report

Test-N°: **8**

Date: 27.04.2006

Test series:

**Ambient Humidity**

Nominal Throughput

1,0 [kg/ms]

<b>Feed:</b>	Input mass:	<u>9350</u> [g]	Temperature:	<u>80</u> [°]
	Time:	<u>31,2</u> [s]	Moisture:	<u>&lt; 0,1</u> [%]
	Throughput:	<u>1,03</u> [kg/ms]	m <sub>&lt;63µm</sub> :	<u>&lt; 5</u> [%]

<b>Ambient air:</b>	Temperature:	<u>40</u> [°C]	Rel. humidity:	<u>40</u> [%]
<b>Separation Chamber:</b>	Temperature:	<u>40</u> [°C]	Rel. humidity:	<u>40</u> [%]

<b>Electrode settings:</b>	pos. (+) top:	<u>5</u> [%]	neg. (-) top:	<u>5</u> [%]
	pos. (+) bottom:	<u>45</u> [%]	neg. (-) bottom:	<u>45</u> [%]

<b>Electrode voltage:</b>	pos. (+):	<u>30,0<sup>1</sup>(31,3<sup>2</sup>)</u> [kV]	neg. (-):	<u>-30,0<sup>1</sup>(-31,7<sup>2</sup>)</u> [kV]
---------------------------	-----------	--	-----------	--

<b>Splitter position:</b>	pos. (+):	<u>20</u> [%]	neg. (-):	<u>20</u> [%]
---------------------------	-----------	---------------	-----------	---------------

<b>Vibratory feeder:</b>	Level:	<u>4,9</u> [-]	Temperature:	<u>150</u> [°]
	Gap width:	<u>8</u> [mm]	Material:	<u>Steel</u>

<b>Feed hopper:</b>	Temperature:	<u>100</u> [°C]
---------------------	--------------	-----------------

<b>Shaker:</b>	Shaft:	<u>ON</u> / OFF	Electrodes:	<u>ON</u> / OFF
----------------	--------	-----------------	-------------	-----------------

<b>Mass of products:</b>	(+) electrode (P):	<u>1478,1</u> [g]
	Middlings (C):	<u>6871,3</u> [g]
	(-) electrode (N):	<u>833,3</u> [g]
	<b>Sum (N+C+P):</b>	<u>9182,7</u> [g]

**Annotations:**

<sup>1</sup> Effective voltage on electrodes (tapped with multimeter)

<sup>2</sup> Nominal voltage (on DC generator display)

# ELECTROSTATIC SEPARATION TESTING

## Test Report

Test-N°: **9**

Date: 02.05.2006

Test series:

**Ambient Humidity**

Nominal Throughput

1,0 [kg/ms]

<b>Feed:</b>	Input mass:	<u>9350</u> [g]	Temperature:	<u>80</u> [°]
	Time:	<u>35,5</u> [s]	Moisture:	<u>&lt; 0,1</u> [%]
	Throughput:	<u>0,91</u> [kg/ms]	m <sub>&lt;63µm</sub> :	<u>&lt; 5</u> [%]

<b>Ambient air:</b>	Temperature:	<u>40</u> [°C]	Rel. humidity:	<u>60</u> [%]
<b>Separation Chamber:</b>	Temperature:	<u>40</u> [°C]	Rel. humidity:	<u>60</u> [%]

<b>Electrode settings:</b>	pos. (+) top:	<u>5</u> [%]	neg. (-) top:	<u>5</u> [%]
	pos. (+) bottom:	<u>45</u> [%]	neg. (-) bottom:	<u>45</u> [%]

<b>Electrode voltage:</b>	pos. (+):	<u>30,0<sup>1</sup>(31,3<sup>2</sup>)</u> [kV]	neg. (-):	<u>-30,0<sup>1</sup>(-31,7<sup>2</sup>)</u> [kV]
---------------------------	-----------	--	-----------	--

<b>Splitter position:</b>	pos. (+):	<u>20</u> [%]	neg. (-):	<u>20</u> [%]
---------------------------	-----------	---------------	-----------	---------------

<b>Vibratory feeder:</b>	Level:	<u>4,9</u> [-]	Temperature:	<u>150</u> [°]
	Gap width:	<u>8</u> [mm]	Material:	<u>Steel</u>

**Feed hopper:** Temperature: 100 [°C]

**Shaker:** Shaft: ON / OFF      Electrodes: ON / OFF

**Mass of products:**

(+) electrode (P):	<u>2684,9</u> [g]
Middlings (C):	<u>5229,2</u> [g]
(-) electrode (N):	<u>1301,9</u> [g]
<b>Sum (N+C+P):</b>	<b><u>9216,0</u> [g]</b>

**Annotations:**

<sup>1</sup> Effective voltage on electrodes (tapped with multimeter)

<sup>2</sup> Nominal voltage (on DC generator display)



# ELECTROSTATIC SEPARATION TESTING

## Test Report

Test-N°: **10**

Date: 02.05.2006

Test series:

**Ambient Humidity**

Nominal Throughput

1,0 [kg/ms]

<b>Feed:</b>	Input mass:	<u>9350</u> [g]	Temperature:	<u>80</u> [°]
	Time:	<u>35,5</u> [s]	Moisture:	<u>&lt; 0,1</u> [%]
	Throughput:	<u>0,91</u> [kg/ms]	m <sub>&lt;63µm</sub> :	<u>&lt; 5</u> [%]

<b>Ambient air:</b>	Temperature:	<u>40</u> [°C]	Rel. humidity:	<u>30</u> [%]
<b>Separation Chamber:</b>	Temperature:	<u>40</u> [°C]	Rel. humidity:	<u>30</u> [%]

<b>Electrode settings:</b>	pos. (+) top:	<u>5</u> [%]	neg. (-) top:	<u>5</u> [%]
	pos. (+) bottom:	<u>45</u> [%]	neg. (-) bottom:	<u>45</u> [%]

<b>Electrode voltage:</b>	pos. (+):	<u>30,0<sup>1</sup>(31,3<sup>2</sup>)</u> [kV]	neg. (-):	<u>-30,0<sup>1</sup>(-31,7<sup>2</sup>)</u> [kV]
---------------------------	-----------	--	-----------	--

<b>Splitter position:</b>	pos. (+):	<u>20</u> [%]	neg. (-):	<u>20</u> [%]
---------------------------	-----------	---------------	-----------	---------------

<b>Vibratory feeder:</b>	Level:	<u>5,0</u> [-]	Temperature:	<u>150</u> [°]
	Gap width:	<u>8</u> [mm]	Material:	<u>Steel</u>

<b>Feed hopper:</b>	Temperature:	<u>100</u> [°C]
---------------------	--------------	-----------------

<b>Shaker:</b>	Shaft:	<u>ON</u> / OFF	Electrodes:	<u>ON</u> / OFF
----------------	--------	-----------------	-------------	-----------------

<b>Mass of products:</b>	(+) electrode (P):	<u>1138,5</u> [g]
	Middlings (C):	<u>6114,0</u> [g]
	(-) electrode (N):	<u>1972,1</u> [g]
	<b>Sum (N+C+P):</b>	<u>9224,6</u> [g]

**Annotations:**

<sup>1</sup> Effective voltage on electrodes (tapped with multimeter)

<sup>2</sup> Nominal voltage (on DC generator display)

# ELECTROSTATIC SEPARATION TESTING

## Test Report

Test-N°: **11**

Date: 02.05.2006

Test series:

**Ambient Humidity**

Nominal Throughput

1,0 [kg/ms]

<b>Feed:</b>	Input mass:	<u>9350</u> [g]	Temperature:	<u>80</u> [°]
	Time:	<u>33,0</u> [s]	Moisture:	<u>&lt; 0,1</u> [%]
	Throughput:	<u>0,98</u> [kg/ms]	m <sub>&lt;63µm</sub> :	<u>&lt; 5</u> [%]

<b>Ambient air:</b>	Temperature:	<u>40</u> [°C]	Rel. humidity:	<u>20</u> [%]
<b>Separation Chamber:</b>	Temperature:	<u>40</u> [°C]	Rel. humidity:	<u>20</u> [%]

<b>Electrode settings:</b>	pos. (+) top:	<u>5</u> [%]	neg. (-) top:	<u>5</u> [%]
	pos. (+) bottom:	<u>45</u> [%]	neg. (-) bottom:	<u>45</u> [%]

<b>Electrode voltage:</b>	pos. (+):	<u>30,0<sup>1</sup>(31,3<sup>2</sup>)</u> [kV]	neg. (-):	<u>-30,0<sup>1</sup>(-31,7<sup>2</sup>)</u> [kV]
---------------------------	-----------	--	-----------	--

<b>Splitter position:</b>	pos. (+):	<u>20</u> [%]	neg. (-):	<u>20</u> [%]
---------------------------	-----------	---------------	-----------	---------------

<b>Vibratory feeder:</b>	Level:	<u>5,0</u> [-]	Temperature:	<u>150</u> [°]
	Gap width:	<u>8</u> [mm]	Material:	<u>Steel</u>

**Feed hopper:** Temperature: 100 [°C]

**Shaker:** Shaft: ON / OFF      Electrodes: ON / OFF

**Mass of products:**

(+) electrode (P):	<u>1151,0</u> [g]
Middlings (C):	<u>4921,5</u> [g]
(-) electrode (N):	<u>3160,8</u> [g]
<b>Sum (N+C+P):</b>	<b><u>9233,3</u> [g]</b>

**Annotations:**

<sup>1</sup> Effective voltage on electrodes (tapped with multimeter)

<sup>2</sup> Nominal voltage (on DC generator display)

# ELECTROSTATIC SEPARATION TESTING

## Test Report

Test-N°: <b>12</b>			
Date: <u>03.05.2006</u>	Test series:	<b>Ambient Humidity</b>	
	Nominal Throughput	<u>1,0</u> [kg/ms]	
<b>Feed:</b>	Input mass: <u>9350</u> [g]	Temperature: <u>80</u> [°]	
	Time: <u>31,0</u> [s]	Moisture: <u>&lt; 0,1</u> [%]	
	Throughput: <u>1,04</u> [kg/ms]	m <sub>&lt;63µm</sub> : <u>&lt; 5</u> [%]	
<b>Ambient air:</b>	Temperature: <u>40</u> [°C]	Rel. humidity: <u>12</u> [%]	
<b>Separation Chamber:</b>	Temperature: <u>40</u> [°C]	Rel. humidity: <u>12</u> [%]	
<b>Electrode settings:</b>	pos. (+) top: <u>5</u> [%]	neg. (-) top: <u>5</u> [%]	
	pos. (+) bottom: <u>45</u> [%]	neg. (-) bottom: <u>45</u> [%]	
<b>Electrode voltage:</b>	pos. (+): <u>30,0<sup>1</sup>(31,3<sup>2</sup>)</u> [kV]	neg. (-): <u>-30,0<sup>1</sup>(-31,7<sup>2</sup>)</u> [kV]	
<b>Splitter position:</b>	pos. (+): <u>20</u> [%]	neg. (-): <u>20</u> [%]	
<b>Vibratory feeder:</b>	Level: <u>5,0</u> [-]	Temperature: <u>150</u> [°]	
	Gap width: <u>8</u> [mm]	Material: <u>Steel</u>	
<b>Feed hopper:</b>	Temperature: <u>100</u> [°C]		
<b>Shaker:</b>	Shaft: <b>ON</b> / OFF	Electrodes: <b>ON</b> / OFF	
<b>Mass of products:</b>	(+) electrode (P): <u>1268,1</u> [g]		
	Middlings (C): <u>4417,1</u> [g]		
	(-) electrode (N): <u>3555,3</u> [g]		
	<b>Sum (N+C+P): <u>9240,5</u> [g]</b>		
<b>Annotations:</b>	<u><sup>1</sup> Effective voltage on electrodes (tapped with multimeter)</u>		
	<u><sup>2</sup> Nominal voltage (on DC generator display)</u>		

# ELECTROSTATIC SEPARATION TESTING

## Test Report

Test-N°: <b>13</b>			
Date: <u>03.05.2006</u>	Test series:	<b>Ambient Humidity</b>	
	Nominal Throughput	<u>1,0</u> [kg/ms]	
<b>Feed:</b>	Input mass: <u>9350</u> [g]	Temperature: <u>80</u> [°]	
	Time: <u>30,5</u> [s]	Moisture: <u>&lt; 0,1</u> [%]	
	Throughput: <u>1,06</u> [kg/ms]	m <sub>&lt;63µm</sub> : <u>&lt; 5</u> [%]	
<b>Ambient air:</b>	Temperature: <u>40</u> [°C]	Rel. humidity: <u>25</u> [%]	
<b>Separation Chamber:</b>	Temperature: <u>40</u> [°C]	Rel. humidity: <u>25</u> [%]	
<b>Electrode settings:</b>	pos. (+) top: <u>5</u> [%]	neg. (-) top: <u>5</u> [%]	
	pos. (+) bottom: <u>45</u> [%]	neg. (-) bottom: <u>45</u> [%]	
<b>Electrode voltage:</b>	pos. (+): <u>30,0<sup>1</sup>(31,3<sup>2</sup>)</u> [kV]	neg. (-): <u>-30,0<sup>1</sup>(-31,7<sup>2</sup>)</u> [kV]	
<b>Splitter position:</b>	pos. (+): <u>20</u> [%]	neg. (-): <u>20</u> [%]	
<b>Vibratory feeder:</b>	Level: <u>5,0</u> [-]	Temperature: <u>150</u> [°]	
	Gap width: <u>8</u> [mm]	Material: <u>Steel</u>	
<b>Feed hopper:</b>	Temperature: <u>100</u> [°C]		
<b>Shaker:</b>	Shaft: <b>ON</b> / OFF	Electrodes: <b>ON</b> / OFF	
<b>Mass of products:</b>	(+) electrode (P): <u>1156,0</u> [g]		
	Middlings (C): <u>6353,5</u> [g]		
	(-) electrode (N): <u>1687,3</u> [g]		
	<b>Sum (N+C+P): <u>9196,8</u> [g]</b>		
<b>Annotations:</b>	<u><sup>1</sup> Effective voltage on electrodes (tapped with multimeter)</u>		
	<u><sup>2</sup> Nominal voltage (on DC generator display)</u>		

# ELECTROSTATIC SEPARATION TESTING

## Test Report

Test-N°: **14**

Date: 10.05.2006

Test series:

**Fines Content**

Nominal Throughput

1,0 [kg/ms]

<b>Feed:</b>	Input mass:	<u>9350</u> [g]	Temperature:	<u>80</u> [°]
	Time:	<u>36,0</u> [s]	Moisture:	<u>&lt; 0,1</u> [%]
	Throughput:	<u>0,90</u> [kg/ms]	<b>m<sub>&lt;63µm</sub>:</b>	<b><u>&lt; 5</u></b> [%]

**Ambient air:** Temperature: 40 [°C] Rel. humidity: 20 [%]

**Separation Chamber:** Temperature: 40 [°C] Rel. humidity: 20 [%]

**Electrode settings:** pos. (+) top: 5 [%] neg. (-) top: 5 [%]  
 pos. (+) bottom: 45 [%] neg. (-) bottom: 45 [%]

**Electrode voltage:** pos. (+): 30,0<sup>1</sup>(31,3<sup>2</sup>) [kV] neg. (-): -30,0<sup>1</sup>(-31,7<sup>2</sup>) [kV]

**Splitter position:** pos. (+): 20 [%] neg. (-): 20 [%]

**Vibratory feeder:** Level: 5,0 [-] Temperature: 150 [°]  
 Gap width: 8 [mm] Material: Steel

**Feed hopper:** Temperature: 100 [°C]

**Shaker:** Shaft: **ON** / OFF Electrodes: **ON** / OFF

**Mass of products:** (+) electrode (P): 1282,7 [g]  
 Middlings (C): 5226,0 [g]  
 (-) electrode (N): 2744,0 [g]  
**Sum (N+C+P): 9252,7 [g]**

**Annotations:** <sup>1</sup> Effective voltage on electrodes (tapped with multimeter)  
<sup>2</sup> Nominal voltage (on DC generator display)

# ELECTROSTATIC SEPARATION TESTING

## Test Report

Test-N°: **15**

Date: 16.05.2006

Test series:

**Fines Content**

Nominal Throughput

1,0 [kg/ms]

<b>Feed:</b>	Input mass:	<u>9350</u> [g]	Temperature:	<u>80</u> [°]
	Time:	<u>34,5</u> [s]	Moisture:	<u>&lt; 0,1</u> [%]
	Throughput:	<u>0,93</u> [kg/ms]	<b>m<sub>&lt;63µm</sub>:</b>	<b><u>10</u> [%]</b>

**Ambient air:** Temperature: 40 [°C] Rel. humidity: 20 [%]

**Separation Chamber:** Temperature: 40 [°C] Rel. humidity: 20 [%]

**Electrode settings:** pos. (+) top: 5 [%] neg. (-) top: 5 [%]  
 pos. (+) bottom: 45 [%] neg. (-) bottom: 45 [%]

**Electrode voltage:** pos. (+): 30,0<sup>1</sup>(31,3<sup>2</sup>) [kV] neg. (-): -30,0<sup>1</sup>(-31,7<sup>2</sup>) [kV]

**Splitter position:** pos. (+): 20 [%] neg. (-): 20 [%]

**Vibratory feeder:** Level: 5,0 [-] Temperature: 150 [°]  
 Gap width: 8 [mm] Material: Steel

**Feed hopper:** Temperature: 100 [°C]

**Shaker:** Shaft: **ON** / OFF Electrodes: **ON** / OFF

**Mass of products:** (+) electrode (P): 1334,7 [g]  
 Middlings (C): 4927,3 [g]  
 (-) electrode (N): 2789,1 [g]  
**Sum (N+C+P): 9051,1 [g]**

**Annotations:** <sup>1</sup> Effective voltage on electrodes (tapped with multimeter)  
<sup>2</sup> Nominal voltage (on DC generator display)

# ELECTROSTATIC SEPARATION TESTING

## Test Report

Test-N°: **16**

Date: 16.05.2006

Test series:

**Fines Content**

Nominal Throughput

1,0 [kg/ms]

<b>Feed:</b>	Input mass:	<u>9350</u> [g]	Temperature:	<u>80</u> [°]
	Time:	<u>33,5</u> [s]	Moisture:	<u>&lt; 0,1</u> [%]
	Throughput:	<u>0,96</u> [kg/ms]	<b>m<sub>&lt;63µm</sub>:</b>	<b><u>15</u> [%]</b>

**Ambient air:** Temperature: 40 [°C] Rel. humidity: 20 [%]

**Separation Chamber:** Temperature: 40 [°C] Rel. humidity: 20 [%]

**Electrode settings:** pos. (+) top: 5 [%] neg. (-) top: 5 [%]  
 pos. (+) bottom: 45 [%] neg. (-) bottom: 45 [%]

**Electrode voltage:** pos. (+): 30,0<sup>1</sup>(31,3<sup>2</sup>) [kV] neg. (-): -30,0<sup>1</sup>(-31,7<sup>2</sup>) [kV]

**Splitter position:** pos. (+): 20 [%] neg. (-): 20 [%]

**Vibratory feeder:** Level: 5-6 [-] Temperature: 150 [°]  
 Gap width: 14 [mm] Material: Steel

**Feed hopper:** Temperature: 100 [°C]

**Shaker:** Shaft: **ON** / OFF Electrodes: **ON** / OFF

**Mass of products:** (+) electrode (P): 1379,4 [g]  
 Middlings (C): 5651,8 [g]  
 (-) electrode (N): 1943,0 [g]  
**Sum (N+C+P): 8974,2 [g]**

**Annotations:** <sup>1</sup> Effective voltage on electrodes (tapped with multimeter)  
<sup>2</sup> Nominal voltage (on DC generator display)

# ELECTROSTATIC SEPARATION TESTING

## Test Report

Test-N°: **17**

Date: 17.05.2006

Test series:

**Fines Content**

Nominal Throughput

1,0 [kg/ms]

<b>Feed:</b>	Input mass:	<u>9350</u> [g]	Temperature:	<u>80</u> [°]
	Time:	<u>34,5</u> [s]	Moisture:	<u>&lt; 0,1</u> [%]
	Throughput:	<u>0,93</u> [kg/ms]	<b>m<sub>&lt;63µm</sub>:</b>	<b><u>20</u></b> [%]

**Ambient air:** Temperature: 40 [°C] Rel. humidity: 20 [%]

**Separation Chamber:** Temperature: 40 [°C] Rel. humidity: 20 [%]

**Electrode settings:** pos. (+) top: 5 [%] neg. (-) top: 5 [%]  
 pos. (+) bottom: 45 [%] neg. (-) bottom: 45 [%]

**Electrode voltage:** pos. (+): 30,0<sup>1</sup>(31,3<sup>2</sup>) [kV] neg. (-): -30,0<sup>1</sup>(-31,7<sup>2</sup>) [kV]

**Splitter position:** pos. (+): 20 [%] neg. (-): 20 [%]

**Vibratory feeder:** Level: 5-6 [-] Temperature: 150 [°]  
 Gap width: 14 [mm] Material: Steel

**Feed hopper:** Temperature: 100 [°C]

**Shaker:** Shaft: **ON** / OFF Electrodes: **ON** / OFF

**Mass of products:** (+) electrode (P): 1254,7 [g]  
 Middlings (C): 5659,1 [g]  
 (-) electrode (N): 1945,0 [g]  
**Sum (N+C+P): 8858,8 [g]**

**Annotations:** <sup>1</sup> Effective voltage on electrodes (tapped with multimeter)  
<sup>2</sup> Nominal voltage (on DC generator display)



# ELECTROSTATIC SEPARATION TESTING

## Test Report

Test-N°: **18**

Date: 17.05.2006

Test series:

**Fines Content**

Nominal Throughput

1,0 [kg/ms]

<b>Feed:</b>	Input mass:	<u>9350</u> [g]	Temperature:	<u>80</u> [°]
	Time:	<u>32,0</u> [s]	Moisture:	<u>&lt; 0,1</u> [%]
	Throughput:	<u>1,01</u> [kg/ms]	<b>m<sub>&lt;63µm</sub>:</b>	<b><u>25</u> [%]</b>

**Ambient air:** Temperature: 40 [°C] Rel. humidity: 20 [%]

**Separation Chamber:** Temperature: 40 [°C] Rel. humidity: 20 [%]

**Electrode settings:** pos. (+) top: 5 [%] neg. (-) top: 5 [%]  
 pos. (+) bottom: 45 [%] neg. (-) bottom: 45 [%]

**Electrode voltage:** pos. (+): 30,0<sup>1</sup>(31,3<sup>2</sup>) [kV] neg. (-): -30,0<sup>1</sup>(-31,7<sup>2</sup>) [kV]

**Splitter position:** pos. (+): 20 [%] neg. (-): 20 [%]

**Vibratory feeder:** Level: 5-6 [-] Temperature: 150 [°]  
 Gap width: 14 [mm] Material: Steel

**Feed hopper:** Temperature: 100 [°C]

**Shaker:** Shaft: **ON** / OFF Electrodes: **ON** / OFF

**Mass of products:** (+) electrode (P): 1594,4 [g]  
 Middlings (C): 5571,5 [g]  
 (-) electrode (N): 1670,7 [g]  
**Sum (N+C+P): 8836,6 [g]**

**Annotations:** <sup>1</sup> Effective voltage on electrodes (tapped with multimeter)  
<sup>2</sup> Nominal voltage (on DC generator display)

# ELECTROSTATIC SEPARATION TESTING

## Test Report

Test-N°: **19**

Date: 17.05.2006

Test series:

**Fines Content**

Nominal Throughput

1,0 [kg/ms]

<b>Feed:</b>	Input mass:	<u>9350</u> [g]	Temperature:	<u>80</u> [°]
	Time:	<u>33,0</u> [s]	Moisture:	<u>&lt; 0,1</u> [%]
	Throughput:	<u>0,98</u> [kg/ms]	<b>m<sub>&lt;63µm</sub>:</b>	<b><u>30</u></b> [%]

**Ambient air:** Temperature: 40 [°C] Rel. humidity: 20 [%]

**Separation Chamber:** Temperature: 40 [°C] Rel. humidity: 20 [%]

**Electrode settings:** pos. (+) top: 5 [%] neg. (-) top: 5 [%]  
 pos. (+) bottom: 45 [%] neg. (-) bottom: 45 [%]

**Electrode voltage:** pos. (+): 30,0<sup>1</sup>(31,3<sup>2</sup>) [kV] neg. (-): -30,0<sup>1</sup>(-31,7<sup>2</sup>) [kV]

**Splitter position:** pos. (+): 20 [%] neg. (-): 20 [%]

**Vibratory feeder:** Level: 5-6 [-] Temperature: 150 [°]  
 Gap width: 14 [mm] Material: Steel

**Feed hopper:** Temperature: 100 [°C]

**Shaker:** Shaft: **ON** / OFF Electrodes: **ON** / OFF

**Mass of products:** (+) electrode (P): 1480,8 [g]  
 Middlings (C): 5470,8 [g]  
 (-) electrode (N): 1808,2 [g]  
**Sum (N+C+P): 8759,8 [g]**

**Annotations:** <sup>1</sup> Effective voltage on electrodes (tapped with multimeter)  
<sup>2</sup> Nominal voltage (on DC generator display)

# ELECTROSTATIC SEPARATION TESTING

## Test Report

<b>Test-N°:</b>	<b>20</b>		
<b>Date:</b>	<u>22.05.2006</u>	<b>Test series:</b>	<b>Splitter position</b>
		Nominal Throughput	<u>1,0</u> [kg/ms]
<b>Feed:</b>	Input mass: <u>9350</u> [g]	Temperature: <u>80</u> [°]	
	Time: <u>32,0</u> [s]	Moisture: <u>&lt; 0,1</u> [%]	
	Throughput: <u>1,01</u> [kg/ms]	m <sub>&lt;63µm</sub> : <u>&lt; 5</u> [%]	
<b>Ambient air:</b>	Temperature: <u>40</u> [°C]	Rel. humidity: <u>20</u> [%]	
<b>Separation Chamber:</b>	Temperature: <u>40</u> [°C]	Rel. humidity: <u>20</u> [%]	
<b>Electrode settings:</b>	pos. (+) top: <u>5</u> [%]	neg. (-) top: <u>5</u> [%]	
	pos. (+) bottom: <u>45</u> [%]	neg. (-) bottom: <u>45</u> [%]	
<b>Electrode voltage:</b>	pos. (+): <u>30,0<sup>1</sup>(31,3<sup>2</sup>)</u> [kV]	neg. (-): <u>-30,0<sup>1</sup>(-31,7<sup>2</sup>)</u> [kV]	
<b>Splitter position:</b>	pos. (+): <b>30</b> [%]	neg. (-): <u>20</u> [%]	
<b>Vibratory feeder:</b>	Level: <u>4,0</u> [-]	Temperature: <u>150</u> [°]	
	Gap width: <u>14</u> [mm]	Material: <u>Steel</u>	
<b>Feed hopper:</b>	Temperature: <u>100</u> [°C]		
<b>Shaker:</b>	Shaft: <b>ON</b> / OFF	Electrodes: <b>ON</b> / OFF	
<b>Mass of products:</b>	(+) electrode (P): <u>801,6</u> [g]		
	Middlings (C): <u>4494,4</u> [g]		
	(-) electrode (N): <u>3934,3</u> [g]		
	<b>Sum (N+C+P):</b> <u><b>9230,3</b></u> [g]		
<b>Annotations:</b>	<u><sup>1</sup> Effective voltage on electrodes (tapped with multimeter)</u>		
	<u><sup>2</sup> Nominal voltage (on DC generator display)</u>		

# ELECTROSTATIC SEPARATION TESTING

## Test Report

<b>Test-N°:</b>	<b>21</b>		
<b>Date:</b>	<u>23.05.2006</u>	<b>Test series:</b>	<b>Splitter position</b>
		Nominal Throughput	<u>1,0</u> [kg/ms]
<b>Feed:</b>	Input mass: <u>9350</u> [g]	Temperature: <u>80</u> [°]	
	Time: <u>33,0</u> [s]	Moisture: <u>&lt; 0,1</u> [%]	
	Throughput: <u>0,98</u> [kg/ms]	m <sub>&lt;63µm</sub> : <u>&lt; 5</u> [%]	
<b>Ambient air:</b>	Temperature: <u>40</u> [°C]	Rel. humidity: <u>20</u> [%]	
<b>Separation Chamber:</b>	Temperature: <u>40</u> [°C]	Rel. humidity: <u>20</u> [%]	
<b>Electrode settings:</b>	pos. (+) top: <u>5</u> [%]	neg. (-) top: <u>5</u> [%]	
	pos. (+) bottom: <u>45</u> [%]	neg. (-) bottom: <u>45</u> [%]	
<b>Electrode voltage:</b>	pos. (+): <u>30,0<sup>1</sup>(31,3<sup>2</sup>)</u> [kV]	neg. (-): <u>-30,0<sup>1</sup>(-31,7<sup>2</sup>)</u> [kV]	
<b>Splitter position:</b>	pos. (+): <b>10</b> [%]	neg. (-): <u>20</u> [%]	
<b>Vibratory feeder:</b>	Level: <u>4,0</u> [-]	Temperature: <u>150</u> [°]	
	Gap width: <u>14</u> [mm]	Material: <u>Steel</u>	
<b>Feed hopper:</b>	Temperature: <u>100</u> [°C]		
<b>Shaker:</b>	Shaft: <b>ON</b> / OFF	Electrodes: <b>ON</b> / OFF	
<b>Mass of products:</b>	(+) electrode (P): <u>1258,0</u> [g]		
	Middlings (C): <u>4190,1</u> [g]		
	(-) electrode (N): <u>3785,5</u> [g]		
	<b>Sum (N+C+P):</b> <u><b>9233,6</b></u> [g]		
<b>Annotations:</b>	<u><sup>1</sup> Effective voltage on electrodes (tapped with multimeter)</u>		
	<u><sup>2</sup> Nominal voltage (on DC generator display)</u>		

# ELECTROSTATIC SEPARATION TESTING

## Test Report

<b>Test-N°:</b>	<b>22</b>		
<b>Date:</b>	<u>23.05.2006</u>	<b>Test series:</b>	<b>Splitter position</b>
		Nominal Throughput	<u>1,0</u> [kg/ms]
<b>Feed:</b>	Input mass: <u>9350</u> [g]	Temperature: <u>80</u> [°]	
	Time: <u>31,5</u> [s]	Moisture: <u>&lt; 0,1</u> [%]	
	Throughput: <u>1,02</u> [kg/ms]	m <sub>&lt;63µm</sub> : <u>&lt; 5</u> [%]	
<b>Ambient air:</b>	Temperature: <u>40</u> [°C]	Rel. humidity: <u>20</u> [%]	
<b>Separation Chamber:</b>	Temperature: <u>40</u> [°C]	Rel. humidity: <u>20</u> [%]	
<b>Electrode settings:</b>	pos. (+) top: <u>5</u> [%]	neg. (-) top: <u>5</u> [%]	
	pos. (+) bottom: <u>45</u> [%]	neg. (-) bottom: <u>45</u> [%]	
<b>Electrode voltage:</b>	pos. (+): <u>30,0<sup>1</sup>(31,3<sup>2</sup>)</u> [kV]	neg. (-): <u>-30,0<sup>1</sup>(-31,7<sup>2</sup>)</u> [kV]	
<b>Splitter position:</b>	pos. (+): <b>10</b> [%]	neg. (-): <u>20</u> [%]	
<b>Vibratory feeder:</b>	Level: <u>3,8</u> [-]	Temperature: <u>150</u> [°]	
	Gap width: <u>14</u> [mm]	Material: <u>Steel</u>	
<b>Feed hopper:</b>	Temperature: <u>100</u> [°C]		
<b>Shaker:</b>	Shaft: <b>ON</b> / OFF	Electrodes: <b>ON</b> / OFF	
<b>Mass of products:</b>	(+) electrode (P): <u>1233,6</u> [g]		
	Middlings (C): <u>4171,0</u> [g]		
	(-) electrode (N): <u>3819,6</u> [g]		
	<b>Sum (N+C+P):</b> <u><b>9224,2</b></u> [g]		
<b>Annotations:</b>	<u><sup>1</sup> Effective voltage on electrodes (tapped with multimeter)</u>		
	<u><sup>2</sup> Nominal voltage (on DC generator display)</u>		

# ELECTROSTATIC SEPARATION TESTING

## Test Report

Test-N°: **23**

Date: 23.05.2006

Test series:

**Splitter position**

Nominal Throughput

1,0 [kg/ms]

<b>Feed:</b>	Input mass:	<u>9350</u> [g]	Temperature:	<u>80</u> [°]
	Time:	<u>33,5</u> [s]	Moisture:	<u>&lt; 0,1</u> [%]
	Throughput:	<u>0,96</u> [kg/ms]	m <sub>&lt;63µm</sub> :	<u>&lt; 5</u> [%]

<b>Ambient air:</b>	Temperature:	<u>40</u> [°C]	Rel. humidity:	<u>20</u> [%]
<b>Separation Chamber:</b>	Temperature:	<u>40</u> [°C]	Rel. humidity:	<u>20</u> [%]

<b>Electrode settings:</b>	pos. (+) top:	<u>5</u> [%]	neg. (-) top:	<u>5</u> [%]
	pos. (+) bottom:	<u>45</u> [%]	neg. (-) bottom:	<u>45</u> [%]

<b>Electrode voltage:</b>	pos. (+):	<u>30,0<sup>1</sup>(31,3<sup>2</sup>)</u> [kV]	neg. (-):	<u>-30,0<sup>1</sup>(-31,7<sup>2</sup>)</u> [kV]
---------------------------	-----------	--	-----------	--

<b>Splitter position:</b>	pos. (+):	<b>20</b> [%]	neg. (-):	<u>20</u> [%]
---------------------------	-----------	---------------	-----------	---------------

<b>Vibratory feeder:</b>	Level:	<u>3,8</u> [-]	Temperature:	<u>150</u> [°]
	Gap width:	<u>14</u> [mm]	Material:	<u>Steel</u>

<b>Feed hopper:</b>	Temperature:	<u>100</u> [°C]
---------------------	--------------	-----------------

<b>Shaker:</b>	Shaft:	<b>ON</b> / OFF	Electrodes:	<b>ON</b> / OFF
----------------	--------	-----------------	-------------	-----------------

<b>Mass of products:</b>	(+) electrode (P):	<u>957,8</u> [g]
	Middlings (C):	<u>4198,9</u> [g]
	(-) electrode (N):	<u>4077,0</u> [g]
	<b>Sum (N+C+P):</b>	<b><u>9233,7</u> [g]</b>

**Annotations:**

<sup>1</sup> Effective voltage on electrodes (tapped with multimeter)

<sup>2</sup> Nominal voltage (on DC generator display)

# ELECTROSTATIC SEPARATION TESTING

## Test Report

<b>Test-N°:</b>	<b>24</b>		
<b>Date:</b>	<u>23.05.2006</u>	<b>Test series:</b>	<b>Splitter position</b>
		Nominal Throughput	<u>1,0</u> [kg/ms]
<b>Feed:</b>	Input mass: <u>9350</u> [g]	Temperature: <u>80</u> [°]	
	Time: <u>33,5</u> [s]	Moisture: <u>&lt; 0,1</u> [%]	
	Throughput: <u>0,96</u> [kg/ms]	m <sub>&lt;63µm</sub> : <u>&lt; 5</u> [%]	
<b>Ambient air:</b>	Temperature: <u>40</u> [°C]	Rel. humidity: <u>20</u> [%]	
<b>Separation Chamber:</b>	Temperature: <u>40</u> [°C]	Rel. humidity: <u>20</u> [%]	
<b>Electrode settings:</b>	pos. (+) top: <u>5</u> [%]	neg. (-) top: <u>5</u> [%]	
	pos. (+) bottom: <u>45</u> [%]	neg. (-) bottom: <u>45</u> [%]	
<b>Electrode voltage:</b>	pos. (+): <u>30,0<sup>1</sup>(31,3<sup>2</sup>)</u> [kV]	neg. (-): <u>-30,0<sup>1</sup>(-31,7<sup>2</sup>)</u> [kV]	
<b>Splitter position:</b>	pos. (+): <b>20</b> [%]	neg. (-): <u>20</u> [%]	
<b>Vibratory feeder:</b>	Level: <u>3,8</u> [-]	Temperature: <u>150</u> [°]	
	Gap width: <u>14</u> [mm]	Material: <u>Steel</u>	
<b>Feed hopper:</b>	Temperature: <u>100</u> [°C]		
<b>Shaker:</b>	Shaft: <b>ON</b> / OFF	Electrodes: <b>ON</b> / OFF	
<b>Mass of products:</b>	(+) electrode (P): <u>994,0</u> [g]		
	Middlings (C): <u>3908,5</u> [g]		
	(-) electrode (N): <u>4294,1</u> [g]		
	<b>Sum (N+C+P):</b> <u><b>9196,6</b></u> [g]		
<b>Annotations:</b>	<u><sup>1</sup> Effective voltage on electrodes (tapped with multimeter)</u>		
	<u><sup>2</sup> Nominal voltage (on DC generator display)</u>		

# ELECTROSTATIC SEPARATION TESTING

## Test Report

Test-N°: <b>25</b>			
Date: <u>24.05.2006</u>	Test series:	<b>Splitter position</b>	
	Nominal Throughput	<u>1,0</u> [kg/ms]	
<b>Feed:</b>	Input mass: <u>9350</u> [g]	Temperature: <u>80</u> [°]	
	Time: <u>33,0</u> [s]	Moisture: <u>&lt; 0,1</u> [%]	
	Throughput: <u>0,98</u> [kg/ms]	m <sub>&lt;63µm</sub> : <u>&lt; 5</u> [%]	
<b>Ambient air:</b>	Temperature: <u>40</u> [°C]	Rel. humidity: <u>20</u> [%]	
<b>Separation Chamber:</b>	Temperature: <u>40</u> [°C]	Rel. humidity: <u>20</u> [%]	
<b>Electrode settings:</b>	pos. (+) top: <u>5</u> [%]	neg. (-) top: <u>5</u> [%]	
	pos. (+) bottom: <u>45</u> [%]	neg. (-) bottom: <u>45</u> [%]	
<b>Electrode voltage:</b>	pos. (+): <u>30,0<sup>1</sup>(31,3<sup>2</sup>)</u> [kV]	neg. (-): <u>-30,0<sup>1</sup>(-31,7<sup>2</sup>)</u> [kV]	
<b>Splitter position:</b>	pos. (+): <b>40</b> [%]	neg. (-): <u>20</u> [%]	
<b>Vibratory feeder:</b>	Level: <u>4,0</u> [-]	Temperature: <u>150</u> [°]	
	Gap width: <u>14</u> [mm]	Material: <u>Steel</u>	
<b>Feed hopper:</b>	Temperature: <u>100</u> [°C]		
<b>Shaker:</b>	Shaft: <b>ON</b> / OFF	Electrodes: <b>ON</b> / OFF	
<b>Mass of products:</b>	(+) electrode (P): <u>656,7</u> [g]		
	Middlings (C): <u>4562,7</u> [g]		
	(-) electrode (N): <u>4007,4</u> [g]		
	<b>Sum (N+C+P): <u>9226,8</u> [g]</b>		
<b>Annotations:</b>	<u><sup>1</sup> Effective voltage on electrodes (tapped with multimeter)</u>		
	<u><sup>2</sup> Nominal voltage (on DC generator display)</u>		



# ELECTROSTATIC SEPARATION TESTING

## Test Report

Test-N°: **26**

Date: 01.06.2006

Test series:

**Moisture**

Nominal Throughput

1,0 [kg/ms]

<b>Feed:</b>	Input mass:	<u>9350</u> [g]	Temperature:	<u>60</u> [°]
	Time:	<u>32,0</u> [s]	<b>Moisture:</b>	<b><u>0,5</u></b> [%]
	Throughput:	<u>1,01</u> [kg/ms]	m <sub>&lt;63µm</sub> :	<u>&lt; 5</u> [%]

**Ambient air:** Temperature: 40 [°C] Rel. humidity: 20 [%]

**Separation Chamber:** Temperature: 40 [°C] Rel. humidity: 20 [%]

<b>Electrode settings:</b>	pos. (+) top:	<u>5</u> [%]	neg. (-) top:	<u>5</u> [%]
	pos. (+) bottom:	<u>45</u> [%]	neg. (-) bottom:	<u>45</u> [%]

**Electrode voltage:** pos. (+): 30,0<sup>1</sup>(31,3<sup>2</sup>) [kV] neg. (-): -30,0<sup>1</sup>(-31,7<sup>2</sup>) [kV]

**Splitter position:** pos. (+): 20 [%] neg. (-): 20 [%]

<b>Vibratory feeder:</b>	Level:	<u>5,0</u> [-]	Temperature:	<u>150</u> [°]
	Gap width:	<u>14</u> [mm]	Material:	<u>Steel</u>

**Feed hopper:** Temperature: 100 [°C]

**Shaker:** Shaft: **ON** / OFF Electrodes: **ON** / OFF

**Mass of products:**

(+) electrode (P):	<u>3306,1</u> [g]
Middlings (C):	<u>2841,6</u> [g]
(-) electrode (N):	<u>2992,9</u> [g]
<b>Sum (N+C+P):</b>	<b><u>9140,6</u></b> [g]

**Annotations:**

<sup>1</sup> Effective voltage on electrodes (tapped with multimeter)

<sup>2</sup> Nominal voltage (on DC generator display)

# ELECTROSTATIC SEPARATION TESTING

## Test Report

Test-N°: 27

Date: 01.06.2006

Test series:

**Moisture**

Nominal Throughput

1,0 [kg/ms]

<b>Feed:</b>	Input mass:	<u>9350</u> [g]	Temperature:	<u>60</u> [°]
	Time:	<u>31,5</u> [s]	<b>Moisture:</b>	<b><u>1,0</u></b> [%]
	Throughput:	<u>1,02</u> [kg/ms]	m <sub>&lt;63µm</sub> :	<u>&lt; 5</u> [%]

**Ambient air:** Temperature: 40 [°C] Rel. humidity: 20 [%]

**Separation Chamber:** Temperature: 40 [°C] Rel. humidity: 20 [%]

<b>Electrode settings:</b>	pos. (+) top:	<u>5</u> [%]	neg. (-) top:	<u>5</u> [%]
	pos. (+) bottom:	<u>45</u> [%]	neg. (-) bottom:	<u>45</u> [%]

**Electrode voltage:** pos. (+): 30,0<sup>1</sup>(31,3<sup>2</sup>) [kV] neg. (-): -30,0<sup>1</sup>(-31,7<sup>2</sup>) [kV]

**Splitter position:** pos. (+): 20 [%] neg. (-): 20 [%]

<b>Vibratory feeder:</b>	Level:	<u>5,0</u> [-]	Temperature:	<u>150</u> [°]
	Gap width:	<u>14</u> [mm]	Material:	<u>Steel</u>

**Feed hopper:** Temperature: 100 [°C]

**Shaker:** Shaft: **ON** / OFF Electrodes: **ON** / OFF

**Mass of products:**

(+) electrode (P):	<u>2920,9</u> [g]
Middlings (C):	<u>3416,9</u> [g]
(-) electrode (N):	<u>2798,6</u> [g]
<b>Sum (N+C+P):</b>	<b><u>9136,4</u></b> [g]

**Annotations:**

<sup>1</sup> Effective voltage on electrodes (tapped with multimeter)

<sup>2</sup> Nominal voltage (on DC generator display)

# ELECTROSTATIC SEPARATION TESTING

## Test Report

Test-N°: 28

Date: 02.06.2006

Test series:

**Moisture**

Nominal Throughput

1,0 [kg/ms]

<b>Feed:</b>	Input mass:	<u>9350</u> [g]	Temperature:	<u>60</u> [°]
	Time:	<u>34,0</u> [s]	Moisture:	<u>&lt; 0,1</u> [%]
	Throughput:	<u>0,95</u> [kg/ms]	m <sub>&lt;63µm</sub> :	<u>&lt; 5</u> [%]

**Ambient air:** Temperature: 40 [°C] Rel. humidity: 20 [%]

**Separation Chamber:** Temperature: 40 [°C] Rel. humidity: 20 [%]

**Electrode settings:** pos. (+) top: 5 [%] neg. (-) top: 5 [%]  
pos. (+) bottom: 45 [%] neg. (-) bottom: 45 [%]

**Electrode voltage:** pos. (+): 30,0<sup>1</sup>(31,3<sup>2</sup>) [kV] neg. (-): -30,0<sup>1</sup>(-31,7<sup>2</sup>) [kV]

**Splitter position:** pos. (+): 20 [%] neg. (-): 20 [%]

**Vibratory feeder:** Level: 4,0 [-] Temperature: 150 [°]  
Gap width: 14 [mm] Material: Steel

**Feed hopper:** Temperature: 100 [°C]

**Shaker:** Shaft: ON / OFF Electrodes: ON / OFF

**Mass of products:** (+) electrode (P): 865,1 [g]  
Middlings (C): 6405,3 [g]  
(-) electrode (N): 1939,8 [g]  
**Sum (N+C+P):** 9210,2 [g]

**Annotations:** <sup>1</sup> Effective voltage on electrodes (tapped with multimeter)  
<sup>2</sup> Nominal voltage (on DC generator display)

# ELECTROSTATIC SEPARATION TESTING

## Test Report

Test-N°: 29

Date: 06.06.2006

Test series:

**Moisture**

Nominal Throughput

1,0 [kg/ms]

<b>Feed:</b>	Input mass:	<u>9350</u> [g]	Temperature:	<u>80</u> [°]
	Time:	<u>33,5</u> [s]	Moisture:	<u>&lt; 0,1</u> [%]
	Throughput:	<u>0,96</u> [kg/ms]	m <sub>&lt;63µm</sub> :	<u>&lt; 5</u> [%]

**Ambient air:** Temperature: 40 [°C] Rel. humidity: 20 [%]

**Separation Chamber:** Temperature: 40 [°C] Rel. humidity: 20 [%]

<b>Electrode settings:</b>	pos. (+) top:	<u>5</u> [%]	neg. (-) top:	<u>5</u> [%]
	pos. (+) bottom:	<u>45</u> [%]	neg. (-) bottom:	<u>45</u> [%]

**Electrode voltage:** pos. (+): 30,0<sup>1</sup>(31,3<sup>2</sup>) [kV] neg. (-): -30,0<sup>1</sup>(-31,7<sup>2</sup>) [kV]

**Splitter position:** pos. (+): 20 [%] neg. (-): 20 [%]

<b>Vibratory feeder:</b>	Level:	<u>4-5</u> [-]	Temperature:	<u>150</u> [°]
	Gap width:	<u>14</u> [mm]	Material:	<u>Steel</u>

**Feed hopper:** Temperature: 100 [°C]

**Shaker:** Shaft: ON / OFF Electrodes: ON / OFF

**Mass of products:**

(+) electrode (P):	<u>1054,7</u> [g]
Middlings (C):	<u>4756,5</u> [g]
(-) electrode (N):	<u>3408,7</u> [g]
<b>Sum (N+C+P):</b>	<b><u>9219,9</u> [g]</b>

**Annotations:**

<sup>1</sup> Effective voltage on electrodes (tapped with multimeter)

<sup>2</sup> Nominal voltage (on DC generator display)

# ELECTROSTATIC SEPARATION TESTING

## Test Report

Test-N°: **30**

Date: 07.06.2006

Test series:

**Moisture**

Nominal Throughput

1,0 [kg/ms]

<b>Feed:</b>	Input mass:	<u>9350</u> [g]	Temperature:	<u>80</u> [°]
	Time:	<u>33,5</u> [s]	<b>Moisture:</b>	<b><u>0,5</u></b> [%]
	Throughput:	<u>0,96</u> [kg/ms]	$m_{<63\mu\text{m}}$ :	<u>&lt; 5</u> [%]

**Ambient air:** Temperature: 40 [°C] Rel. humidity: 20 [%]

**Separation Chamber:** Temperature: 40 [°C] Rel. humidity: 20 [%]

**Electrode settings:** pos. (+) top: 5 [%] neg. (-) top: 5 [%]  
pos. (+) bottom: 45 [%] neg. (-) bottom: 45 [%]

**Electrode voltage:** pos. (+): 30,0<sup>1</sup>(31,3<sup>2</sup>) [kV] neg. (-): -30,0<sup>1</sup>(-31,7<sup>2</sup>) [kV]

**Splitter position:** pos. (+): 20 [%] neg. (-): 20 [%]

**Vibratory feeder:** Level: 4,0 [-] Temperature: 150 [°]  
Gap width: 14 [mm] Material: Steel

**Feed hopper:** Temperature: 100 [°C]

**Shaker:** Shaft: **ON** / OFF Electrodes: **ON** / OFF

**Mass of products:** (+) electrode (P): 3054,8 [g]  
Middlings (C): 3738,7 [g]  
(-) electrode (N): 2346,7 [g]  
**Sum (N+C+P): 9140,2 [g]**

**Annotations:** <sup>1</sup> Effective voltage on electrodes (tapped with multimeter)  
<sup>2</sup> Nominal voltage (on DC generator display)

# ELECTROSTATIC SEPARATION TESTING

## Test Report

Test-N°: **31**

Date: 07.06.2006

Test series:

**Moisture**

Nominal Throughput

1,0 [kg/ms]

<b>Feed:</b>	Input mass:	<u>9350</u> [g]	Temperature:	<u>80</u> [°]
	Time:	<u>32,5</u> [s]	<b>Moisture:</b>	<b><u>1,0</u></b> [%]
	Throughput:	<u>0,99</u> [kg/ms]	m <sub>&lt;63µm</sub> :	<u>&lt; 5</u> [%]

**Ambient air:** Temperature: 40 [°C] Rel. humidity: 20 [%]

**Separation Chamber:** Temperature: 40 [°C] Rel. humidity: 20 [%]

<b>Electrode settings:</b>	pos. (+) top:	<u>5</u> [%]	neg. (-) top:	<u>5</u> [%]
	pos. (+) bottom:	<u>45</u> [%]	neg. (-) bottom:	<u>45</u> [%]

**Electrode voltage:** pos. (+): 30,0<sup>1</sup>(31,3<sup>2</sup>) [kV] neg. (-): -30,0<sup>1</sup>(-31,7<sup>2</sup>) [kV]

**Splitter position:** pos. (+): 20 [%] neg. (-): 20 [%]

<b>Vibratory feeder:</b>	Level:	<u>4,0</u> [-]	Temperature:	<u>150</u> [°]
	Gap width:	<u>14</u> [mm]	Material:	<u>Steel</u>

**Feed hopper:** Temperature: 100 [°C]

**Shaker:** Shaft: **ON** / OFF Electrodes: **ON** / OFF

**Mass of products:**

(+) electrode (P):	<u>3243,6</u> [g]
Middlings (C):	<u>2245,9</u> [g]
(-) electrode (N):	<u>3518,0</u> [g]
<b>Sum (N+C+P):</b>	<b><u>9007,5</u></b> [g]

**Annotations:**

<sup>1</sup> Effective voltage on electrodes (tapped with multimeter)

<sup>2</sup> Nominal voltage (on DC generator display)

# ELECTROSTATIC SEPARATION TESTING

## Test Report

Test-N°: **32**

Date: 08.06.2006

Test series:

**Vibratory Feeder Temp.**

Nominal Throughput

1,0 [kg/ms]

<b>Feed:</b>	Input mass:	<u>9350</u> [g]	Temperature:	<u>80</u> [°]
	Time:	<u>34,0</u> [s]	Moisture:	<u>&lt; 0,1</u> [%]
	Throughput:	<u>0,95</u> [kg/ms]	m <sub>&lt;63µm</sub> :	<u>&lt; 5</u> [%]

<b>Ambient air:</b>	Temperature:	<u>40</u> [°C]	Rel. humidity:	<u>20</u> [%]
<b>Separation Chamber:</b>	Temperature:	<u>40</u> [°C]	Rel. humidity:	<u>20</u> [%]

<b>Electrode settings:</b>	pos. (+) top:	<u>5</u> [%]	neg. (-) top:	<u>5</u> [%]
	pos. (+) bottom:	<u>45</u> [%]	neg. (-) bottom:	<u>45</u> [%]

<b>Electrode voltage:</b>	pos. (+):	<u>30,0<sup>1</sup>(31,3<sup>2</sup>)</u> [kV]	neg. (-):	<u>-30,0<sup>1</sup>(-31,7<sup>2</sup>)</u> [kV]
---------------------------	-----------	--	-----------	--

<b>Splitter position:</b>	pos. (+):	<u>20</u> [%]	neg. (-):	<u>20</u> [%]
---------------------------	-----------	---------------	-----------	---------------

<b>Vibratory feeder:</b>	Level:	<u>3,6</u> [-]	Temperature:	<b>150</b> [°]
	Gap width:	<u>14</u> [mm]	Material:	<u>Steel</u>

<b>Feed hopper:</b>	Temperature:	<u>100</u> [°C]
---------------------	--------------	-----------------

<b>Shaker:</b>	Shaft:	<b>ON</b> / OFF	Electrodes:	<b>ON</b> / OFF
----------------	--------	-----------------	-------------	-----------------

<b>Mass of products:</b>	(+) electrode (P):	<u>1034,0</u> [g]
	Middlings (C):	<u>3716,2</u> [g]
	(-) electrode (N):	<u>4478,6</u> [g]
	<b>Sum (N+C+P):</b>	<b><u>9228,8</u> [g]</b>

**Annotations:**

<sup>1</sup> Effective voltage on electrodes (tapped with multimeter)

<sup>2</sup> Nominal voltage (on DC generator display)

# ELECTROSTATIC SEPARATION TESTING

## Test Report

Test-N°: **33**

Date: 08.06.2006

Test series:

**Vibratory Feeder Temp.**

Nominal Throughput

1,0 [kg/ms]

<b>Feed:</b>	Input mass:	<u>9350</u> [g]	Temperature:	<u>80</u> [°]
	Time:	<u>34,0</u> [s]	Moisture:	<u>&lt; 0,1</u> [%]
	Throughput:	<u>0,95</u> [kg/ms]	m <sub>&lt;63µm</sub> :	<u>&lt; 5</u> [%]

**Ambient air:** Temperature: 40 [°C] Rel. humidity: 20 [%]

**Separation Chamber:** Temperature: 40 [°C] Rel. humidity: 20 [%]

<b>Electrode settings:</b>	pos. (+) top:	<u>5</u> [%]	neg. (-) top:	<u>5</u> [%]
	pos. (+) bottom:	<u>45</u> [%]	neg. (-) bottom:	<u>45</u> [%]

**Electrode voltage:** pos. (+): 30,0<sup>1</sup>(31,3<sup>2</sup>) [kV] neg. (-): -30,0<sup>1</sup>(-31,7<sup>2</sup>) [kV]

**Splitter position:** pos. (+): 20 [%] neg. (-): 20 [%]

**Vibratory feeder:** Level: 5,7 [-] **Temperature:** 120 [°]

Gap width: 14 [mm] Material: Steel

**Feed hopper:** Temperature: 100 [°C]

**Shaker:** Shaft: ON / OFF Electrodes: ON / OFF

**Mass of products:**

(+) electrode (P):	<u>969,5</u> [g]
Middlings (C):	<u>4081,4</u> [g]
(-) electrode (N):	<u>4150,0</u> [g]
<b>Sum (N+C+P):</b>	<b><u>9200,9</u> [g]</b>

**Annotations:** <sup>1</sup> Effective voltage on electrodes (tapped with multimeter)

<sup>2</sup> Nominal voltage (on DC generator display)



# ELECTROSTATIC SEPARATION TESTING

## Test Report

Test-N°: **34**

Date: 08.06.2006

Test series:

**Vibratory Feeder Temp.**

Nominal Throughput

1,0 [kg/ms]

<b>Feed:</b>	Input mass:	<u>9350</u> [g]	Temperature:	<u>80</u> [°]
	Time:	<u>33,0</u> [s]	Moisture:	<u>&lt; 0,1</u> [%]
	Throughput:	<u>0,98</u> [kg/ms]	m <sub>&lt;63µm</sub> :	<u>&lt; 5</u> [%]

<b>Ambient air:</b>	Temperature:	<u>40</u> [°C]	Rel. humidity:	<u>20</u> [%]
---------------------	--------------	----------------	----------------	---------------

<b>Separation Chamber:</b>	Temperature:	<u>40</u> [°C]	Rel. humidity:	<u>20</u> [%]
----------------------------	--------------	----------------	----------------	---------------

<b>Electrode settings:</b>	pos. (+) top:	<u>5</u> [%]	neg. (-) top:	<u>5</u> [%]
	pos. (+) bottom:	<u>45</u> [%]	neg. (-) bottom:	<u>45</u> [%]

<b>Electrode voltage:</b>	pos. (+):	<u>30,0<sup>1</sup>(31,3<sup>2</sup>)</u> [kV]	neg. (-):	<u>-30,0<sup>1</sup>(-31,7<sup>2</sup>)</u> [kV]
---------------------------	-----------	--	-----------	--

<b>Splitter position:</b>	pos. (+):	<u>20</u> [%]	neg. (-):	<u>20</u> [%]
---------------------------	-----------	---------------	-----------	---------------

<b>Vibratory feeder:</b>	Level:	<u>4,8</u> [-]	Temperature:	<b>80</b> [°]
--------------------------	--------	----------------	--------------	---------------

Gap width:	<u>14</u> [mm]	Material:	<u>Steel</u>
------------	----------------	-----------	--------------

<b>Feed hopper:</b>	Temperature:	<u>100</u> [°C]
---------------------	--------------	-----------------

<b>Shaker:</b>	Shaft:	<b>ON</b> / OFF	Electrodes:	<b>ON</b> / OFF
----------------	--------	-----------------	-------------	-----------------

<b>Mass of products:</b>	(+) electrode (P):	<u>1035,5</u> [g]
	Middlings (C):	<u>4082,9</u> [g]
	(-) electrode (N):	<u>4090,1</u> [g]
	<b>Sum (N+C+P):</b>	<b><u>9208,5</u> [g]</b>

**Annotations:** <sup>1</sup> Effective voltage on electrodes (tapped with multimeter)

<sup>2</sup> Nominal voltage (on DC generator display)

# ELECTROSTATIC SEPARATION TESTING

## Test Report

Test-N°: **35**

Date: 09.06.2006

Test series:

**Vibratory Feeder Temp.**

Nominal Throughput

1,0 [kg/ms]

<b>Feed:</b>	Input mass:	<u>9350</u> [g]	Temperature:	<u>80</u> [°]
	Time:	<u>33,0</u> [s]	Moisture:	<u>&lt; 0,1</u> [%]
	Throughput:	<u>0,98</u> [kg/ms]	m <sub>&lt;63µm</sub> :	<u>&lt; 5</u> [%]

<b>Ambient air:</b>	Temperature:	<u>40</u> [°C]	Rel. humidity:	<u>20</u> [%]
---------------------	--------------	----------------	----------------	---------------

<b>Separation Chamber:</b>	Temperature:	<u>40</u> [°C]	Rel. humidity:	<u>20</u> [%]
----------------------------	--------------	----------------	----------------	---------------

<b>Electrode settings:</b>	pos. (+) top:	<u>5</u> [%]	neg. (-) top:	<u>5</u> [%]
	pos. (+) bottom:	<u>45</u> [%]	neg. (-) bottom:	<u>45</u> [%]

<b>Electrode voltage:</b>	pos. (+):	<u>30,0<sup>1</sup>(31,3<sup>2</sup>)</u> [kV]	neg. (-):	<u>-30,0<sup>1</sup>(-31,7<sup>2</sup>)</u> [kV]
---------------------------	-----------	--	-----------	--

<b>Splitter position:</b>	pos. (+):	<u>20</u> [%]	neg. (-):	<u>20</u> [%]
---------------------------	-----------	---------------	-----------	---------------

<b>Vibratory feeder:</b>	Level:	<u>4-6</u> [-]	Temperature:	<b>RT = 40</b> [°]
--------------------------	--------	----------------	--------------	--------------------

Gap width:	<u>14</u> [mm]	Material:	<u>Steel</u>
------------	----------------	-----------	--------------

<b>Feed hopper:</b>	Temperature:	<u>100</u> [°C]
---------------------	--------------	-----------------

<b>Shaker:</b>	Shaft:	<b>ON</b> / OFF	Electrodes:	<b>ON</b> / OFF
----------------	--------	-----------------	-------------	-----------------

<b>Mass of products:</b>	(+) electrode (P):	<u>942,2</u> [g]
	Middlings (C):	<u>5855,5</u> [g]
	(-) electrode (N):	<u>2398,7</u> [g]
	<b>Sum (N+C+P):</b>	<b><u>9196,4</u> [g]</b>

**Annotations:** <sup>1</sup> Effective voltage on electrodes (tapped with multimeter)

<sup>2</sup> Nominal voltage (on DC generator display)

# ELECTROSTATIC SEPARATION TESTING

## Test Report

Test-N°: **36**

Date: 12.06.2006

Test series:

**Vibratory Feeder Temp.**

Nominal Throughput

1,0 [kg/ms]

<b>Feed:</b>	Input mass:	<u>9350</u> [g]	Temperature:	<u>80</u> [°]
	Time:	<u>32,5</u> [s]	Moisture:	<u>&lt; 0,1</u> [%]
	Throughput:	<u>0,99</u> [kg/ms]	m <sub>&lt;63µm</sub> :	<u>&lt; 5</u> [%]

<b>Ambient air:</b>	Temperature:	<u>40</u> [°C]	Rel. humidity:	<u>20</u> [%]
---------------------	--------------	----------------	----------------	---------------

<b>Separation Chamber:</b>	Temperature:	<u>40</u> [°C]	Rel. humidity:	<u>20</u> [%]
----------------------------	--------------	----------------	----------------	---------------

<b>Electrode settings:</b>	pos. (+) top:	<u>5</u> [%]	neg. (-) top:	<u>5</u> [%]
	pos. (+) bottom:	<u>45</u> [%]	neg. (-) bottom:	<u>45</u> [%]

<b>Electrode voltage:</b>	pos. (+):	<u>30,0<sup>1</sup>(31,3<sup>2</sup>)</u> [kV]	neg. (-):	<u>-30,0<sup>1</sup>(-31,7<sup>2</sup>)</u> [kV]
---------------------------	-----------	--	-----------	--

<b>Splitter position:</b>	pos. (+):	<u>20</u> [%]	neg. (-):	<u>20</u> [%]
---------------------------	-----------	---------------	-----------	---------------

<b>Vibratory feeder:</b>	Level:	<u>5-6</u> [-]	Temperature:	<b>RT = 40</b> [°]
--------------------------	--------	----------------	--------------	--------------------

Gap width:	<u>14</u> [mm]	Material:	<u>Steel</u>
------------	----------------	-----------	--------------

<b>Feed hopper:</b>	Temperature:	<u>100</u> [°C]
---------------------	--------------	-----------------

<b>Shaker:</b>	Shaft:	<b>ON</b> / OFF	Electrodes:	<b>ON</b> / OFF
----------------	--------	-----------------	-------------	-----------------

<b>Mass of products:</b>	(+) electrode (P):	<u>1037,2</u> [g]
	Middlings (C):	<u>6373,1</u> [g]
	(-) electrode (N):	<u>1782,3</u> [g]
	<b>Sum (N+C+P):</b>	<b><u>9192,6</u> [g]</b>

**Annotations:** <sup>1</sup> Effective voltage on electrodes (tapped with multimeter)

<sup>2</sup> Nominal voltage (on DC generator display)

# ELECTROSTATIC SEPARATION TESTING

## Test Report

Test-N°: **37**

Date: 20.06.2006

Test series:

**Feed Temperature**

Nominal Throughput

1,0 [kg/ms]

<b>Feed:</b>	Input mass:	<u>9350</u> [g]	Temperature:	<b>90</b> [°]
	Time:	<u>32,0</u> [s]	Moisture:	<u>&lt; 0,1</u> [%]
	Throughput:	<u>1,01</u> [kg/ms]	m <sub>&lt;63µm</sub> :	<u>&lt; 5</u> [%]

**Ambient air:** Temperature: 40 [°C] Rel. humidity: 20 [%]

**Separation Chamber:** Temperature: 40 [°C] Rel. humidity: 20 [%]

**Electrode settings:** pos. (+) top: 5 [%] neg. (-) top: 5 [%]  
 pos. (+) bottom: 45 [%] neg. (-) bottom: 45 [%]

**Electrode voltage:** pos. (+): 30,0<sup>1</sup>(31,3<sup>2</sup>) [kV] neg. (-): -30,0<sup>1</sup>(-31,7<sup>2</sup>) [kV]

**Splitter position:** pos. (+): 20 [%] neg. (-): 20 [%]

**Precharging Shaft:** Material: Copper

**Vibratory feeder:** Level: 5,3 [-] Temperature: 100 [°]

Gap width: 14 [mm] Material: Steel

**Feed hopper:** Temperature: 100 [°C]

**Shaker:** Shaft: **ON** / OFF Electrodes: **ON** / OFF

**Mass of products:** (+) electrode (P): 1169,7 [g]

Middlings (C): 5542,8 [g]

(-) electrode (N): 2498,6 [g]

**Sum (N+C+P):** 9211,1 [g]

**Annotations:** <sup>1</sup> Effective voltage on electrodes (tapped with multimeter)

<sup>2</sup> Nominal voltage (on DC generator display)

# ELECTROSTATIC SEPARATION TESTING

## Test Report

Test-N°: **38**

Date: 21.06.2006

Test series:

**Feed Temperature**

Nominal Throughput

1,0 [kg/ms]

<b>Feed:</b>	Input mass:	<u>9350</u> [g]	Temperature:	<b>80</b> [°]
	Time:	<u>33,5</u> [s]	Moisture:	<u>&lt; 0,1</u> [%]
	Throughput:	<u>0,96</u> [kg/ms]	m <sub>&lt;63µm</sub> :	<u>&lt; 5</u> [%]

**Ambient air:** Temperature: 40 [°C] Rel. humidity: 20 [%]

**Separation Chamber:** Temperature: 40 [°C] Rel. humidity: 20 [%]

**Electrode settings:**

pos. (+) top:	<u>5</u> [%]	neg. (-) top:	<u>5</u> [%]
pos. (+) bottom:	<u>45</u> [%]	neg. (-) bottom:	<u>45</u> [%]

**Electrode voltage:** pos. (+): 30,0<sup>1</sup>(31,3<sup>2</sup>) [kV] neg. (-): -30,0<sup>1</sup>(-31,7<sup>2</sup>) [kV]

**Splitter position:** pos. (+): 20 [%] neg. (-): 20 [%]

**Precharging Shaft:** Material: Copper

**Vibratory feeder:** Level: 5,1 [-] Temperature: 100 [°]

Gap width: 14 [mm] Material: Steel

**Feed hopper:** Temperature: 100 [°C]

**Shaker:** Shaft: **ON** / OFF Electrodes: **ON** / OFF

**Mass of products:** (+) electrode (P): 1135,8 [g]

Middlings (C): 6573,1 [g]

(-) electrode (N): 1505,8 [g]

**Sum (N+C+P):** 9214,7 [g]

**Annotations:** <sup>1</sup> Effective voltage on electrodes (tapped with multimeter)

<sup>2</sup> Nominal voltage (on DC generator display)

# ELECTROSTATIC SEPARATION TESTING

## Test Report

Test-N°: **39**

Date: 21.06.2006

Test series:

**Feed Temperature**

Nominal Throughput

1,0 [kg/ms]

<b>Feed:</b>	Input mass:	<u>9350</u> [g]	Temperature:	<b>70</b> [°]
	Time:	<u>31,0</u> [s]	Moisture:	<u>&lt; 0,1</u> [%]
	Throughput:	<u>1,04</u> [kg/ms]	m <sub>&lt;63µm</sub> :	<u>&lt; 5</u> [%]

**Ambient air:** Temperature: 40 [°C] Rel. humidity: 20 [%]

**Separation Chamber:** Temperature: 40 [°C] Rel. humidity: 20 [%]

**Electrode settings:** pos. (+) top: 5 [%] neg. (-) top: 5 [%]  
 pos. (+) bottom: 45 [%] neg. (-) bottom: 45 [%]

**Electrode voltage:** pos. (+): 30,0<sup>1</sup>(31,3<sup>2</sup>) [kV] neg. (-): -30,0<sup>1</sup>(-31,7<sup>2</sup>) [kV]

**Splitter position:** pos. (+): 20 [%] neg. (-): 20 [%]

**Precharging Shaft:** Material: Copper

**Vibratory feeder:** Level: 5,0 [-] Temperature: 100 [°]

Gap width: 14 [mm] Material: Steel

**Feed hopper:** Temperature: 100 [°C]

**Shaker:** Shaft: **ON** / OFF Electrodes: **ON** / OFF

**Mass of products:** (+) electrode (P): 981,9 [g]

Middlings (C): 7466,1 [g]

(-) electrode (N): 763,5 [g]

**Sum (N+C+P):** 9211,5 [g]

**Annotations:** <sup>1</sup> Effective voltage on electrodes (tapped with multimeter)

<sup>2</sup> Nominal voltage (on DC generator display)

# ELECTROSTATIC SEPARATION TESTING

## Test Report

Test-N°: **40**

Date: 21.06.2006

Test series:

**Feed Temperature**

Nominal Throughput 1,0 [kg/ms]

<b>Feed:</b>	Input mass:	<u>9350</u> [g]	Temperature:	<b>60</b> [°]
	Time:	<u>31,0</u> [s]	Moisture:	<u>&lt; 0,1</u> [%]
	Throughput:	<u>1,04</u> [kg/ms]	m <sub>&lt;63µm</sub> :	<u>&lt; 5</u> [%]

**Ambient air:** Temperature: 40 [°C] Rel. humidity: 20 [%]

**Separation Chamber:** Temperature: 40 [°C] Rel. humidity: 20 [%]

**Electrode settings:** pos. (+) top: 5 [%] neg. (-) top: 5 [%]  
 pos. (+) bottom: 45 [%] neg. (-) bottom: 45 [%]

**Electrode voltage:** pos. (+): 30,0<sup>1</sup>(31,3<sup>2</sup>) [kV] neg. (-): -30,0<sup>1</sup>(-31,7<sup>2</sup>) [kV]

**Splitter position:** pos. (+): 20 [%] neg. (-): 20 [%]

**Precharging Shaft:** Material: Copper

**Vibratory feeder:** Level: 5,0 [-] Temperature: 100 [°]

Gap width: 14 [mm] Material: Steel

**Feed hopper:** Temperature: 100 [°C]

**Shaker:** Shaft: **ON** / OFF Electrodes: **ON** / OFF

**Mass of products:** (+) electrode (P): 1115,9 [g]

Middlings (C): 7201,0 [g]

(-) electrode (N): 894,6 [g]

**Sum (N+C+P):** 9211,5 [g]

**Annotations:** <sup>1</sup> Effective voltage on electrodes (tapped with multimeter)

<sup>2</sup> Nominal voltage (on DC generator display)

# ELECTROSTATIC SEPARATION TESTING

## Test Report

Test-N°: **41**

Date: 21.06.2006

Test series:

**Feed Temperature**

Nominal Throughput

1,0 [kg/ms]

<b>Feed:</b>	Input mass:	<u>9350</u> [g]	Temperature:	<b>RT=40</b> [°]
	Time:	<u>34,0</u> [s]	Moisture:	<u>&lt; 0,1</u> [%]
	Throughput:	<u>0,95</u> [kg/ms]	m <sub>&lt;63µm</sub> :	<u>&lt; 5</u> [%]

**Ambient air:** Temperature: 40 [°C] Rel. humidity: 20 [%]

**Separation Chamber:** Temperature: 40 [°C] Rel. humidity: 20 [%]

**Electrode settings:** pos. (+) top: 5 [%] neg. (-) top: 5 [%]  
 pos. (+) bottom: 45 [%] neg. (-) bottom: 45 [%]

**Electrode voltage:** pos. (+): 30,0<sup>1</sup>(31,3<sup>2</sup>) [kV] neg. (-): -30,0<sup>1</sup>(-31,7<sup>2</sup>) [kV]

**Splitter position:** pos. (+): 20 [%] neg. (-): 20 [%]

**Precharging Shaft:** Material: Copper

**Vibratory feeder:** Level: 5,0 [-] Temperature: 100 [°]

Gap width: 14 [mm] Material: Steel

**Feed hopper:** Temperature: 100 [°C]

**Shaker:** Shaft: **ON** / OFF Electrodes: **ON** / OFF

**Mass of products:** (+) electrode (P): 3643,0 [g]

Middlings (C): 3467,5 [g]

(-) electrode (N): 2098,6 [g]

**Sum (N+C+P):** 9209,1 [g]

**Annotations:** <sup>1</sup> Effective voltage on electrodes (tapped with multimeter)

<sup>2</sup> Nominal voltage (on DC generator display)



# ELECTROSTATIC SEPARATION TESTING

## Test Report

Test-N°: **42**

Date: 22.06.2006

Test series:

**Feed Temperature**

Nominal Throughput

1,0 [kg/ms]

<b>Feed:</b>	Input mass:	<u>9350</u> [g]	Temperature:	<b>60</b> [°]
	Time:	<u>31,5</u> [s]	Moisture:	<u>&lt; 0,1</u> [%]
	Throughput:	<u>1,02</u> [kg/ms]	m <sub>&lt;63µm</sub> :	<u>&lt; 5</u> [%]

**Ambient air:** Temperature: 40 [°C] Rel. humidity: 20 [%]

**Separation Chamber:** Temperature: 40 [°C] Rel. humidity: 20 [%]

**Electrode settings:**

pos. (+) top:	<u>5</u> [%]	neg. (-) top:	<u>5</u> [%]
pos. (+) bottom:	<u>45</u> [%]	neg. (-) bottom:	<u>45</u> [%]

**Electrode voltage:** pos. (+): 30,0<sup>1</sup>(31,3<sup>2</sup>) [kV] neg. (-): -30,0<sup>1</sup>(-31,7<sup>2</sup>) [kV]

**Splitter position:** pos. (+): 20 [%] neg. (-): 20 [%]

**Precharging Shaft:** Material: Steel

**Vibratory feeder:** Level: 5,0 [-] Temperature: 100 [°]

Gap width: 14 [mm] Material: Steel

**Feed hopper:** Temperature: 100 [°C]

**Shaker:** Shaft: **ON** / OFF Electrodes: **ON** / OFF

**Mass of products:** (+) electrode (P): 1098,8 [g]

Middlings (C): 6777,4 [g]

(-) electrode (N): 1329,7 [g]

**Sum (N+C+P):** 9205,9 [g]

**Annotations:** <sup>1</sup> Effective voltage on electrodes (tapped with multimeter)

<sup>2</sup> Nominal voltage (on DC generator display)

# ELECTROSTATIC SEPARATION TESTING

## Test Report

Test-N°: **43**

Date: 23.06.2006

Test series:

**Feed Temperature**

Nominal Throughput

1,0 [kg/ms]

<b>Feed:</b>	Input mass:	<u>9350</u> [g]	Temperature:	<b>70</b> [°]
	Time:	<u>31,5</u> [s]	Moisture:	<u>&lt; 0,1</u> [%]
	Throughput:	<u>1,02</u> [kg/ms]	m <sub>&lt;63µm</sub> :	<u>&lt; 5</u> [%]

**Ambient air:** Temperature: 40 [°C] Rel. humidity: 20 [%]

**Separation Chamber:** Temperature: 40 [°C] Rel. humidity: 20 [%]

**Electrode settings:** pos. (+) top: 5 [%] neg. (-) top: 5 [%]  
 pos. (+) bottom: 45 [%] neg. (-) bottom: 45 [%]

**Electrode voltage:** pos. (+): 30,0<sup>1</sup>(31,3<sup>2</sup>) [kV] neg. (-): -30,0<sup>1</sup>(-31,7<sup>2</sup>) [kV]

**Splitter position:** pos. (+): 20 [%] neg. (-): 20 [%]

**Precharging Shaft:** Material: Steel

**Vibratory feeder:** Level: 5,0-5,1 [-] Temperature: 100 [°]

Gap width: 14 [mm] Material: Steel

**Feed hopper:** Temperature: 100 [°C]

**Shaker:** Shaft: **ON** / OFF Electrodes: **ON** / OFF

**Mass of products:** (+) electrode (P): 671,1 [g]

Middlings (C): 7336,7 [g]

(-) electrode (N): 1175,7 [g]

**Sum (N+C+P):** 9183,5 [g]

**Annotations:** <sup>1</sup> Effective voltage on electrodes (tapped with multimeter)

<sup>2</sup> Nominal voltage (on DC generator display)

# ELECTROSTATIC SEPARATION TESTING

## Test Report

Test-N°: **44**

Date: 23.06.2006

Test series:

**Feed Temperature**

Nominal Throughput

1,0 [kg/ms]

<b>Feed:</b>	Input mass:	<u>9350</u> [g]	Temperature:	<b>80</b> [°]
	Time:	<u>33,0</u> [s]	Moisture:	<u>&lt; 0,1</u> [%]
	Throughput:	<u>0,98</u> [kg/ms]	m <sub>&lt;63µm</sub> :	<u>&lt; 5</u> [%]

**Ambient air:** Temperature: 40 [°C] Rel. humidity: 20 [%]

**Separation Chamber:** Temperature: 40 [°C] Rel. humidity: 20 [%]

**Electrode settings:** pos. (+) top: 5 [%] neg. (-) top: 5 [%]  
 pos. (+) bottom: 45 [%] neg. (-) bottom: 45 [%]

**Electrode voltage:** pos. (+): 30,0<sup>1</sup>(31,3<sup>2</sup>) [kV] neg. (-): -30,0<sup>1</sup>(-31,7<sup>2</sup>) [kV]

**Splitter position:** pos. (+): 20 [%] neg. (-): 20 [%]

**Precharging Shaft:** Material: Steel

**Vibratory feeder:** Level: 5,1 [-] Temperature: 100 [°]

Gap width: 14 [mm] Material: Steel

**Feed hopper:** Temperature: 100 [°C]

**Shaker:** Shaft: **ON** / OFF Electrodes: **ON** / OFF

**Mass of products:** (+) electrode (P): 788,0 [g]

Middlings (C): 6200,1 [g]

(-) electrode (N): 2223,5 [g]

**Sum (N+C+P):** 9211,6 [g]

**Annotations:** <sup>1</sup> Effective voltage on electrodes (tapped with multimeter)

<sup>2</sup> Nominal voltage (on DC generator display)

# ELECTROSTATIC SEPARATION TESTING

## Test Report

Test-N°: **45**

Date: 23.06.2006

Test series:

**Feed Temperature**

Nominal Throughput

1,0 [kg/ms]

<b>Feed:</b>	Input mass:	<u>9350</u> [g]	Temperature:	<b>90</b> [°]
	Time:	<u>32,0</u> [s]	Moisture:	<u>&lt; 0,1</u> [%]
	Throughput:	<u>1,01</u> [kg/ms]	m <sub>&lt;63µm</sub> :	<u>&lt; 5</u> [%]

**Ambient air:** Temperature: 40 [°C] Rel. humidity: 20 [%]

**Separation Chamber:** Temperature: 40 [°C] Rel. humidity: 20 [%]

**Electrode settings:** pos. (+) top: 5 [%] neg. (-) top: 5 [%]  
 pos. (+) bottom: 45 [%] neg. (-) bottom: 45 [%]

**Electrode voltage:** pos. (+): 30,0<sup>1</sup>(31,3<sup>2</sup>) [kV] neg. (-): -30,0<sup>1</sup>(-31,7<sup>2</sup>) [kV]

**Splitter position:** pos. (+): 20 [%] neg. (-): 20 [%]

**Precharging Shaft:** Material: Steel

**Vibratory feeder:** Level: 5,1 [-] Temperature: 100 [°]

Gap width: 14 [mm] Material: Steel

**Feed hopper:** Temperature: 100 [°C]

**Shaker:** Shaft: **ON** / OFF Electrodes: **ON** / OFF

**Mass of products:** (+) electrode (P): 910,7 [g]

Middlings (C): 5078,0 [g]

(-) electrode (N): 3225,1 [g]

**Sum (N+C+P):** 9213,8 [g]

**Annotations:** <sup>1</sup> Effective voltage on electrodes (tapped with multimeter)

<sup>2</sup> Nominal voltage (on DC generator display)

# ELECTROSTATIC SEPARATION TESTING

## Test Report

Test-N°: **46**

Date: 26.06.2006

Test series:

**Feed Temperature**

Nominal Throughput

1,0 [kg/ms]

<b>Feed:</b>	Input mass:	<u>9350</u> [g]	Temperature:	<b>RT=40°C</b> [°]
	Time:	<u>34,0</u> [s]	Moisture:	<u>&lt; 0,1</u> [%]
	Throughput:	<u>0,95</u> [kg/ms]	m <sub>&lt;63µm</sub> :	<u>&lt; 5</u> [%]

**Ambient air:** Temperature: 40 [°C] Rel. humidity: 20 [%]

**Separation Chamber:** Temperature: 40 [°C] Rel. humidity: 20 [%]

**Electrode settings:** pos. (+) top: 5 [%] neg. (-) top: 5 [%]  
 pos. (+) bottom: 45 [%] neg. (-) bottom: 45 [%]

**Electrode voltage:** pos. (+): 30,0<sup>1</sup>(31,3<sup>2</sup>) [kV] neg. (-): -30,0<sup>1</sup>(-31,7<sup>2</sup>) [kV]

**Splitter position:** pos. (+): 20 [%] neg. (-): 20 [%]

**Precharging Shaft:** Material: Steel

**Vibratory feeder:** Level: 5,0 [-] Temperature: 100 [°]

Gap width: 14 [mm] Material: Steel

**Feed hopper:** Temperature: 100 [°C]

**Shaker:** Shaft: **ON** / OFF Electrodes: **ON** / OFF

**Mass of products:** (+) electrode (P): 3476,4 [g]

Middlings (C): 3095,3 [g]

(-) electrode (N): 2643,9 [g]

**Sum (N+C+P):** 9215,6 [g]

**Annotations:** <sup>1</sup> Effective voltage on electrodes (tapped with multimeter)

<sup>2</sup> Nominal voltage (on DC generator display)

# ELECTROSTATIC SEPARATION TESTING

## Test Report

Test-N°: **47**

Date: 05.07.2006

Test series: **Multistage separation**

Nominal Throughput 1,0 [kg/ms]

<b>Feed:</b>	Input mass:	<u>20000</u> [g]	Temperature:	<u>80</u> [°]
	Time:	<u>68,0</u> [s]	Moisture:	<u>&lt; 0,1</u> [%]
	Throughput:	<u>1,01</u> [kg/ms]	m <sub>&lt;63µm</sub> :	<u>&lt; 5</u> [%]

<b>Ambient air:</b>	Temperature:	<u>40</u> [°C]	Rel. humidity:	<u>20</u> [%]
<b>Separation Chamber:</b>	Temperature:	<u>40</u> [°C]	Rel. humidity:	<u>20</u> [%]

<b>Electrode settings:</b>	pos. (+) top:	<u>5</u> [%]	neg. (-) top:	<u>5</u> [%]
	pos. (+) bottom:	<u>45</u> [%]	neg. (-) bottom:	<u>45</u> [%]

<b>Electrode voltage:</b>	pos. (+):	<u>30,0<sup>1</sup>(31,3<sup>2</sup>)</u> [kV]	neg. (-):	<u>-30,0<sup>1</sup>(-31,7<sup>2</sup>)</u> [kV]
---------------------------	-----------	--	-----------	--

<b>Splitter position:</b>	pos. (+):	<u>20</u> [%]	neg. (-):	<u>20</u> [%]
---------------------------	-----------	---------------	-----------	---------------

**Precharging Shaft:** Material: Copper

<b>Vibratory feeder:</b>	Level:	<u>5,0</u> [-]	Temperature:	<u>100</u> [°]
	Gap width:	<u>14</u> [mm]	Material:	<u>Steel</u>

**Feed hopper:** Temperature: 100 [°C]

**Shaker:** Shaft: **ON** / OFF      Electrodes: **ON** / OFF

<b>Mass of products:</b>	(+) electrode (P):	<u>2259,9</u> [g]
	Middlings (C):	<u>12146,0</u> [g]
	(-) electrode (N):	<u>5298,3</u> [g]
	<b>Sum (N+C+P):</b>	<b><u>19704,2</u> [g]</b>

**Annotations:** <sup>1</sup> Effective voltage on electrodes (tapped with multimeter)  
<sup>2</sup> Nominal voltage (on DC generator display)

# ELECTROSTATIC SEPARATION TESTING

## Test Report

Test-N°: **47-1**

Date: 05.07.2006

Test series: **Multistage separation**

Nominal Throughput 1,0 [kg/ms]

<b>Feed:</b> (= 47 N)	Input mass:	<u>4951</u> [g]	Temperature:	<u>80</u> [°]
	Time:	<u>18,0</u> [s]	Moisture:	<u>&lt; 0,1</u> [%]
	Throughput:	<u>0,95</u> [kg/ms]	m <sub>&lt;63µm</sub> :	<u>n.a.</u> [%]

**Ambient air:** Temperature: 40 [°C] Rel. humidity: 20 [%]

**Separation Chamber:** Temperature: 40 [°C] Rel. humidity: 20 [%]

<b>Electrode settings:</b>	pos. (+) top:	<u>5</u> [%]	neg. (-) top:	<u>5</u> [%]
	pos. (+) bottom:	<u>45</u> [%]	neg. (-) bottom:	<u>45</u> [%]

**Electrode voltage:** pos. (+): 30,0<sup>1</sup>(31,3<sup>2</sup>) [kV] neg. (-): -30,0<sup>1</sup>(-31,7<sup>2</sup>) [kV]

**Splitter position:** pos. (+): 20 [%] neg. (-): 20 [%]

**Precharging Shaft:** Material: Copper

**Vibratory feeder:** Level: 5,2 [-] Temperature: 100 [°]

Gap width: 14 [mm] Material: Steel

**Feed hopper:** Temperature: 100 [°C]

**Shaker:** Shaft: **ON** / OFF Electrodes: **ON** / OFF

**Mass of products:** (+) electrode (P): 303,0 [g]

Middlings (C): 4305,0 [g]

(-) electrode (N): 244,6 [g]

**Sum (N+C+P):** 4852,6 [g]

**Annotations:** <sup>1</sup> Effective voltage on electrodes (tapped with multimeter)

<sup>2</sup> Nominal voltage (on DC generator display)

# ELECTROSTATIC SEPARATION TESTING

## Test Report

Test-N°: **47-2**

Date: 05.07.2006

Test series: **Multistage separation**

Nominal Throughput 1,0 [kg/ms]

<b>Feed:</b> (= 47 C)	Input mass:	<u>11400</u> [g]	Temperature:	<u>80</u> [°]
	Time:	<u>41,0</u> [s]	Moisture:	<u>&lt; 0,1</u> [%]
	Throughput:	<u>0,96</u> [kg/ms]	m <sub>&lt;63µm</sub> :	<u>n.a.</u> [%]

**Ambient air:** Temperature: 40 [°C] Rel. humidity: 20 [%]

**Separation Chamber:** Temperature: 40 [°C] Rel. humidity: 20 [%]

<b>Electrode settings:</b>	pos. (+) top:	<u>5</u> [%]	neg. (-) top:	<u>5</u> [%]
	pos. (+) bottom:	<u>45</u> [%]	neg. (-) bottom:	<u>45</u> [%]

**Electrode voltage:** pos. (+): 30,0<sup>1</sup>(31,3<sup>2</sup>) [kV] neg. (-): -30,0<sup>1</sup>(-31,7<sup>2</sup>) [kV]

**Splitter position:** pos. (+): 20 [%] neg. (-): 20 [%]

**Precharging Shaft:** Material: Copper

**Vibratory feeder:** Level: 5-6 [-] Temperature: 100 [°]

Gap width: 14 [mm] Material: Steel

**Feed hopper:** Temperature: 100 [°C]

**Shaker:** Shaft: **ON** / OFF Electrodes: **ON** / OFF

**Mass of products:** (+) electrode (P): 1067,6 [g]

Middlings (C): 8015,4 [g]

(-) electrode (N): 2188,0 [g]

**Sum (N+C+P):** 11271,0 [g]

**Annotations:** <sup>1</sup> Effective voltage on electrodes (tapped with multimeter)

<sup>2</sup> Nominal voltage (on DC generator display)



# ELECTROSTATIC SEPARATION TESTING

## Test Report

Test-N°: **47-3**

Date: 05.07.2006

Test series: **Multistage separation**

Nominal Throughput 1,0 [kg/ms]

<b>Feed:</b> (= 47 P)	Input mass:	<u>1956</u> [g]	Temperature:	<u>80</u> [°]
	Time:	<u>6,5</u> [s]	Moisture:	<u>&lt; 0,1</u> [%]
	Throughput:	<u>1,04</u> [kg/ms]	m <sub>&lt;63µm</sub> :	<u>n.a.</u> [%]

**Ambient air:** Temperature: 40 [°C] Rel. humidity: 20 [%]

**Separation Chamber:** Temperature: 40 [°C] Rel. humidity: 20 [%]

<b>Electrode settings:</b>	pos. (+) top:	<u>5</u> [%]	neg. (-) top:	<u>5</u> [%]
	pos. (+) bottom:	<u>45</u> [%]	neg. (-) bottom:	<u>45</u> [%]

**Electrode voltage:** pos. (+): 30,0<sup>1</sup>(31,3<sup>2</sup>) [kV] neg. (-): -30,0<sup>1</sup>(-31,7<sup>2</sup>) [kV]

**Splitter position:** pos. (+): 20 [%] neg. (-): 20 [%]

**Precharging Shaft:** Material: Copper

**Vibratory feeder:** Level: 5,0 [-] Temperature: 100 [°]

Gap width: 14 [mm] Material: Steel

**Feed hopper:** Temperature: 100 [°C]

**Shaker:** Shaft: **ON** / OFF Electrodes: **ON** / OFF

**Mass of products:** (+) electrode (P): 628,5 [g]

Middlings (C): 759,8 [g]

(-) electrode (N): 538,2 [g]

**Sum (N+C+P):** 1926,5 [g]

**Annotations:** <sup>1</sup> Effective voltage on electrodes (tapped with multimeter)

<sup>2</sup> Nominal voltage (on DC generator display)

## Analysis of triboelectrostatic separation tests

Sample Test	Marble 1	Yield mass		Class																						
				HCl-Insol.				Carbonate				Cumulated product														
				a [%]	e [%%]	r [%]	r [%]	a [%]	e [%%]	r [%]	r [%]	a [%]	e [%%]	a [%]	e [%%]	r [%]										
Index	Designation	[g]	[%]																							
1 N	(-)	6014,3	65,17	0,51	33,24	3,41	71,83	99,49	6483,79	71,83	0,51	33,24	99,49	6483,79	71,83	0,51	33,24	99,49	6483,79	71,83	0,51	33,24	99,49	6483,79	71,83	
1 C	(o)	1804,0	19,55	2,29	44,76	4,60	21,16	97,71	1910,03	21,16	<b>0,92</b>	78,00	99,08	8393,81	<b>92,99</b>											
1 P	(+)	1410,3	15,28	<b>58,61</b>	895,67	<b>91,99</b>	7,01	41,39	632,52	7,01	9,74	973,67	90,26	9026,33	100,00	9,74	973,67	90,26	9026,33	100,00	9,74	973,67	90,26	9026,33	100,00	
1 F	Feed	9228,6	100,00	9,74	973,67	100,00	100,00	90,26	9026,33	100,00	-	-	-	-	-	-	-	-	-	-	-	-	-	-	-	-
		measured value:		9,37																						

Sample Test	Marble 2	Yield mass		Class																						
				HCl-Insol.				Carbonate				Cumulated product														
				a [%]	e [%%]	r [%]	r [%]	a [%]	e [%%]	r [%]	r [%]	a [%]	e [%%]	a [%]	e [%%]	r [%]										
Index	Designation	[g]	[%]																							
2 N	(-)	5652,2	61,25	0,57	34,91	3,58	67,49	99,43	6090,27	67,49	0,57	34,91	99,43	6090,27	67,49	0,57	34,91	99,43	6090,27	67,49	0,57	34,91	99,43	6090,27	67,49	
2 C	(o)	2302,4	24,95	3,15	78,59	8,06	26,78	96,85	2416,47	26,78	<b>1,32</b>	113,51	98,68	8506,75	<b>94,27</b>											
2 P	(+)	1273,2	13,80	<b>62,49</b>	862,20	<b>88,37</b>	5,73	37,51	517,54	5,73	9,76	975,71	90,24	9024,29	100,00	9,76	975,71	90,24	9024,29	100,00	9,76	975,71	90,24	9024,29	100,00	
2 F	Feed	9227,8	100,00	9,76	975,71	100,00	100,00	90,24	9024,29	100,00	-	-	-	-	-	-	-	-	-	-	-	-	-	-	-	-
		measured value:		9,66																						

### Analysis of triboelectrostatic separation tests

Sample Test	Marble 3	Yield mass		Class																								
				HCl-Insol.				Carbonate				Cumulated product																
				a [%]	e [%%]	r [%]		a [%]	e [%%]	r [%]		a [%]	e [%%]	r [%]														
Index	Designation	[g]	[%]																									
3 N	(-)	4288,6	46,53	0,40	18,61	1,99	99,60	4634,11	51,13	0,40	18,61	1,99	99,60	4634,11	51,13	0,40	18,61	1,99	99,60	4634,11	51,13	0,40	18,61	1,99	99,60	4634,11	51,13	
3 C	(o)	3660,9	39,72	3,05	121,14	12,93	96,95	3850,59	42,49	1,62	139,75	12,93	96,95	3850,59	42,49	1,62	139,75	12,93	96,95	3850,59	42,49	1,62	139,75	12,93	96,95	3850,59	42,49	
3 P	(+)	1267,9	13,76	57,97	797,41	85,09	42,03	578,14	6,38	9,37	937,16	85,09	42,03	578,14	6,38	9,37	937,16	85,09	42,03	578,14	6,38	9,37	937,16	85,09	42,03	578,14	6,38	
3 F	Feed	9217,4	100,00	9,37	937,16	100,00	90,63	9062,84	100,00	-	-	-	90,63	9062,84	100,00	-	-	-	90,63	9062,84	100,00	-	-	-	-	90,63	9062,84	100,00
		measured value:		9,90																								

Sample Test	Marble 4	Yield mass		Class																										
				HCl-Insol.				Carbonate				Cumulated product																		
				a [%]	e [%%]	r [%]		a [%]	e [%%]	r [%]		a [%]	e [%%]	r [%]																
Index	Designation	[g]	[%]																											
4 N	(-)	3862,7	41,92	1,44	60,37	5,88	98,56	4131,66	46,05	1,44	60,37	5,88	98,56	4131,66	46,05	1,44	60,37	5,88	98,56	4131,66	46,05	1,44	60,37	5,88	98,56	4131,66	46,05	1,44	60,37	5,88
4 C	(o)	4136,6	44,89	3,91	175,53	17,09	96,09	4313,75	48,07	2,72	235,90	17,09	96,09	4313,75	48,07	2,72	235,90	17,09	96,09	4313,75	48,07	2,72	235,90	17,09	96,09	4313,75	48,07	2,72	235,90	17,09
4 P	(+)	1215,1	13,19	59,99	791,09	77,03	40,01	527,61	5,88	10,27	1026,98	77,03	40,01	527,61	5,88	10,27	1026,98	77,03	40,01	527,61	5,88	10,27	1026,98	77,03	40,01	527,61	5,88	10,27	1026,98	77,03
4 F	Feed	9214,4	100,00	10,27	1026,98	100,00	89,73	8973,02	100,00	-	-	-	89,73	8973,02	100,00	-	-	-	89,73	8973,02	100,00	-	-	-	-	89,73	8973,02	100,00	-	-
		measured value:		10,00																										

## Analysis of triboelectrostatic separation tests

Sample Test	Marble 5	Yield mass		Class																				
				HCl-Insol.				Carbonate				Cumulated product												
				a [%]	e [%%]	r [%]	r [%]	a [%]	e [%%]	r [%]	r [%]	a [%]	e [%%]	a [%]	e [%%]	r [%]								
Index	Designation	[g]	[%]																					
5 N	(-)	2976,4	32,35	0,43	13,91	1,38	99,57	3220,82	35,81	0,43	13,91	99,57	3220,82	35,81	0,43	13,91	99,57	3220,82	35,81					
5 C	(o)	5081,1	55,22	4,96	273,90	27,24	95,04	5248,20	58,35	<b>3,29</b>	287,81	96,71	8469,01	<b>94,16</b>										
5 P	(+)	1143,9	12,43	<b>57,72</b>	717,56	<b>71,37</b>	42,28	525,62	5,84	10,05	1005,37	89,95	8994,63	100,00										
5 F	Feed	9201,4	100,00	10,05	1005,37	100,00	89,95	8994,63	100,00	-	-	-	-	-										
		measured value:		9,86																				

Sample Test	Marble 6	Yield mass		Class																				
				HCl-Insol.				Carbonate				Cumulated product												
				a [%]	e [%%]	r [%]	r [%]	a [%]	e [%%]	r [%]	r [%]	a [%]	e [%%]	a [%]	e [%%]	r [%]								
Index	Designation	[g]	[%]																					
6 N	(-)	1683,8	18,23	0,54	9,85	1,05	99,46	1813,49	20,02	0,54	9,85	99,46	1813,49	20,02	0,54	9,85	99,46	1813,49	20,02					
6 C	(o)	6657,7	72,09	5,63	405,89	43,09	94,37	6803,55	75,11	<b>4,60</b>	415,74	95,40	8617,04	<b>95,13</b>										
6 P	(+)	893,2	9,67	<b>54,41</b>	526,27	<b>55,87</b>	45,59	440,96	4,87	9,42	942,00	90,58	9058,00	100,00										
6 F	Feed	9234,7	100,00	9,42	942,00	100,00	90,58	9058,00	100,00	-	-	-	-	-										
		measured value:		9,74																				

## Analysis of triboelectrostatic separation tests

Sample Test	Marble 7	Yield mass		Class						Cumulated product						
		[g]	[%]	HCl-Insol.			Carbonate			Yield mass [%]	HCl-Insol.			Carbonate		
				a [%]	e [%%]	r [%]	a [%]	e [%%]	r [%]		a [%]	e [%%]	r [%]	a [%]	e [%%]	r [%]
7 N	(-)	1524,5	16,58	0,62	10,28	1,04	99,38	1647,99	18,28	16,58	0,62	10,28	99,38	1647,99	18,28	
7 C	(o)	6905,1	75,11	6,94	521,26	52,90	93,06	6989,75	77,54	<b>91,69</b>	<b>5,80</b>	531,55	94,20	8637,74	<b>95,82</b>	
7 P	(+)	763,7	8,31	<b>54,63</b>	453,82	<b>46,06</b>	45,37	376,89	4,18	100,00	9,85	985,36	90,15	9014,64	100,00	
7 F	Feed	9193,3	100,00	9,85	985,36	100,00	90,15	9014,64	100,00	-	-	-	-	-	-	
		measured value:		9,36												

Sample Test	Marble 8	Yield mass		Class						Cumulated product						
		[g]	[%]	HCl-Insol.			Carbonate			Yield mass [%]	HCl-Insol.			Carbonate		
				a [%]	e [%%]	r [%]	a [%]	e [%%]	r [%]		a [%]	e [%%]	r [%]	a [%]	e [%%]	r [%]
8 N	(-)	833,3	9,07	5,49	49,82	4,77	94,51	857,65	9,58	9,07	5,49	49,82	94,51	857,65	9,58	
8 C	(o)	6871,3	74,83	8,44	631,55	60,52	91,56	6851,32	76,50	<b>83,90</b>	<b>8,12</b>	681,37	91,88	7708,97	<b>86,07</b>	
8 P	(+)	1478,1	16,10	<b>22,50</b>	362,17	<b>34,71</b>	77,50	1247,48	13,93	100,00	10,44	1043,55	89,56	8956,45	100,00	
8 F	Feed	9182,7	100,00	10,44	1043,55	100,00	89,56	8956,45	100,00	-	-	-	-	-	-	
		measured value:		10,23												

## Analysis of triboelectrostatic separation tests

Sample Test	Marble 9	Yield mass		Class																	
				HCl-Insol.				Carbonate				Cumulated product									
				a [%]	e [%%]	r [%]	r [%]	a [%]	e [%%]	r [%]	r [%]	a [%]	e [%%]	a [%]	e [%%]	r [%]					
Index	Designation	[g]	[%]	1301,9	14,13	8,71	123,04	12,49	14,30	91,29	1289,61	14,30	91,29	1289,61	14,30	8,71	123,04	91,29	1289,61	14,30	
9 N	(-)																				
9 C	(o)	5229,2	56,74	8,15	462,43	46,95	57,81	91,85	5211,61	57,81	70,87	585,48	8,26	91,74	6501,22	72,11					
9 P	(+)	2684,9	29,13	13,71	399,41	40,55	27,89	86,29	2513,89	27,89	100,00	984,89	9,85	90,15	9015,11	100,00					
9 F	Feed	9216,0	100,00	9,85	984,89	100,00	100,00	90,15	9015,11	100,00	-	-	-	-	-	-	-	-	-	-	-
		measured value:		-																	

Sample Test	Marble 10	Yield mass		Class																	
				HCl-Insol.				Carbonate				Cumulated product									
				a [%]	e [%%]	r [%]	r [%]	a [%]	e [%%]	r [%]	r [%]	a [%]	e [%%]	a [%]	e [%%]	r [%]					
Index	Designation	[g]	[%]	1972,1	21,38	1,33	28,43	2,84	23,44	98,67	2109,44	23,44	98,67	2109,44	23,44	1,33	28,43	98,67	2109,44	23,44	
10 N	(-)																				
10 C	(o)	6114,0	66,28	5,18	343,33	34,33	69,83	94,82	6284,60	69,83	87,66	371,76	4,24	95,76	8394,04	93,27					
10 P	(+)	1138,5	12,34	50,90	628,21	62,82	6,73	49,10	605,99	6,73	100,00	999,97	10,00	90,00	9000,03	100,00					
10 F	Feed	9224,6	100,00	10,00	999,97	100,00	100,00	90,00	9000,03	100,00	-	-	-	-	-	-	-	-	-	-	-
		measured value:		10,47																	

## Analysis of triboelectrostatic separation tests

Sample Test	Marble 11 Designation	Yield mass		Class						Cumulated product						
		[g]	[%]	HCl-Insol.			Carbonate			Yield mass [%]	HCl-Insol.			Carbonate		
				a [%]	e [%%]	r [%]	a [%]	e [%%]	r [%]		a [%]	e [%%]	r [%]	a [%]	e [%%]	r [%]
11 N	(-)	3160,8	34,23	0,73	24,99	2,54	99,27	3398,27	37,70	34,23	0,73	24,99	99,27	3398,27	37,70	
11 C	(o)	4921,5	53,30	3,96	211,07	21,42	96,04	5119,09	56,79	<b>87,53</b>	<b>2,70</b>	236,06	97,30	8517,36	<b>94,48</b>	
11 P	(+)	1151,0	12,47	<b>60,10</b>	749,19	<b>76,04</b>	39,90	497,38	5,52	100,00	9,85	985,26	90,15	9014,74	100,00	
11 F	Feed	9233,3	100,00	9,85	985,26	100,00	90,15	9014,74	100,00	-	-	-	-	-	-	
		measured value:		9,69												

Sample Test	Marble 12 Designation	Yield mass		Class						Cumulated product						
		[g]	[%]	HCl-Insol.			Carbonate			Yield mass [%]	HCl-Insol.			Carbonate		
				a [%]	e [%%]	r [%]	a [%]	e [%%]	r [%]		a [%]	e [%%]	r [%]	a [%]	e [%%]	r [%]
12 N	(-)	3555,3	38,48	0,54	20,78	2,07	99,46	3826,74	42,53	38,48	0,54	20,78	99,46	3826,74	42,53	
12 C	(o)	4417,1	47,80	3,05	145,79	14,55	96,95	4634,36	51,50	<b>86,28</b>	<b>1,93</b>	166,57	98,07	8461,10	<b>94,03</b>	
12 P	(+)	1268,1	13,72	<b>60,88</b>	835,47	<b>83,38</b>	39,12	536,85	5,97	100,00	10,02	1002,04	89,98	8997,96	100,00	
12 F	Feed	9240,5	100,00	10,02	1002,04	100,00	89,98	8997,96	100,00	-	-	-	-	-	-	
		measured value:		10,79												

## Analysis of triboelectrostatic separation tests

Sample Test	Marble Designation	Yield mass		Class											
				HCl-Insol.				Carbonate				Cumulated product			
				a [%]	e [%%]	r [%]	r [%]	a [%]	e [%%]	r [%]	r [%]	a [%]	e [%%]	a [%]	e [%%]
13 N	(-)	1687,3	18,35	1,12	20,55	2,01	98,88	1814,11	20,21	98,88	1814,11	20,55	98,88	1814,11	20,21
13 C	(o)	6353,5	69,08	4,73	326,77	31,96	95,27	6581,61	73,31	95,27	6581,61	347,31	96,03	8395,73	<b>93,52</b>
13 P	(+)	1156,0	12,57	<b>53,70</b>	674,99	<b>66,03</b>	46,30	581,97	6,48	46,30	581,97	1022,30	89,78	8977,70	100,00
13 F	Feed	9196,8	100,00	10,22	1022,30	100,00	89,78	8977,70	100,00	89,78	8977,70	-	-	-	-
		measured value:		10,27											

Sample Test	Marble Designation	Yield mass		Class											
				HCl-Insol.				Carbonate				Cumulated product			
				a [%]	e [%%]	r [%]	r [%]	a [%]	e [%%]	r [%]	r [%]	a [%]	e [%%]	a [%]	e [%%]
14 N	(-)	2744,0	29,66	0,87	25,80	2,54	99,13	2939,82	32,72	99,13	2939,82	25,80	99,13	2939,82	32,72
14 C	(o)	5226,0	56,48	4,54	256,42	25,23	95,46	5391,66	60,02	95,46	5391,66	282,22	96,72	8331,48	<b>92,74</b>
14 P	(+)	1282,7	13,86	<b>52,95</b>	734,04	<b>72,23</b>	47,05	652,25	7,26	47,05	652,25	1016,27	89,84	8983,73	100,00
14 F	Feed	9252,7	100,00	10,16	1016,27	100,00	89,84	8983,73	100,00	89,84	8983,73	-	-	-	-
		measured value:		10,75											



## Analysis of triboelectrostatic separation tests

Sample Test	Marble 15 Designation	Yield mass		Class											
		[g]	[%]	HCl-Insol.			Carbonate			Yield mass [%]	Cumulated product				
				a [%]	e [%%]	r [%]	a [%]	e [%%]	r [%]		a [%]	e [%%]	r [%]		
15 N	(-)	2789,1	30,82	1,07	32,97	3,22	98,93	3048,53	33,96	30,82	1,07	32,97	98,93	3048,53	33,96
15 C	(o)	4927,3	54,44	4,54	247,15	24,16	95,46	5196,72	57,89	<b>85,25</b>	<b>3,29</b>	280,12	96,71	8245,25	<b>91,85</b>
15 P	(+)	1334,7	14,75	<b>50,39</b>	743,06	<b>72,62</b>	49,61	731,56	8,15	100,00	10,23	1023,19	89,77	8976,81	100,00
15 F	Feed	9051,1	100,00	10,23	1023,19	100,00	89,77	8976,81	100,00	-	-	-	-	-	-
		measured value:		10,17											

Sample Test	Marble 16 Designation	Yield mass		Class											
		[g]	[%]	HCl-Insol.			Carbonate			Yield mass [%]	Cumulated product				
				a [%]	e [%%]	r [%]	a [%]	e [%%]	r [%]		a [%]	e [%%]	r [%]		
16 N	(-)	1943,0	21,65	1,41	30,53	2,99	98,59	2134,57	23,77	21,65	1,41	30,53	98,59	2134,57	23,77
16 C	(o)	5651,8	62,98	5,54	348,90	34,23	94,46	5948,93	66,24	<b>84,63</b>	<b>4,48</b>	379,43	95,52	8083,50	<b>90,01</b>
16 P	(+)	1379,4	15,37	<b>41,63</b>	639,88	<b>62,78</b>	58,37	897,19	9,99	100,00	10,19	1019,31	89,81	8980,69	100,00
16 F	Feed	8974,2	100,00	10,19	1019,31	100,00	89,81	8980,69	100,00	-	-	-	-	-	-
		measured value:		10,28											

## Analysis of triboelectrostatic separation tests

Sample Test	Marble Designation	Yield mass		Class						Cumulated product						
		[g]	[%]	HCl-Insol.			Carbonate			Yield mass [%]	HCl-Insol.			Carbonate		
				a [%]	e [%%]	r [%]	a [%]	e [%%]	r [%]		a [%]	e [%%]	r [%]	a [%]	e [%%]	r [%]
17 N	(-)	1945,0	21,96	1,27	27,88	2,60	98,73	2167,67	24,28	21,96	1,27	27,88	98,73	2167,67	24,28	
17 C	(o)	5659,1	63,88	6,13	391,59	36,57	93,87	5996,52	67,16	<b>85,84</b>	<b>4,89</b>	419,47	95,11	8164,19	<b>91,43</b>	
17 P	(+)	1254,7	14,16	<b>45,99</b>	651,37	<b>60,83</b>	54,01	764,96	8,57	100,00	10,71	1070,85	89,29	8929,15	100,00	
17 F	Feed	8858,8	100,00	10,71	1070,85	100,00	89,29	8929,15	100,00	-	-	-	-	-	-	
		measured value:		10,29												

Sample Test	Marble Designation	Yield mass		Class						Cumulated product						
		[g]	[%]	HCl-Insol.			Carbonate			Yield mass [%]	HCl-Insol.			Carbonate		
				a [%]	e [%%]	r [%]	a [%]	e [%%]	r [%]		a [%]	e [%%]	r [%]	a [%]	e [%%]	r [%]
18 N	(-)	1670,7	18,91	1,80	34,03	3,34	98,20	1856,63	20,67	18,91	1,80	34,03	98,20	1856,63	20,67	
18 C	(o)	5571,5	63,05	6,55	412,98	40,58	93,45	5892,05	65,60	<b>81,96</b>	<b>5,45</b>	447,01	94,55	7748,67	<b>86,27</b>	
18 P	(+)	1594,4	18,04	<b>31,63</b>	570,70	<b>56,08</b>	68,37	1233,61	13,73	100,00	10,18	1017,72	89,82	8982,28	100,00	
18 F	Feed	8836,6	100,00	10,18	1017,72	100,00	89,82	8982,28	100,00	-	-	-	-	-	-	
		measured value:		10,08												

## Analysis of triboelectrostatic separation tests

Sample Test	Marble Designation	Yield mass		Class											
				HCl-Insol.				Carbonate				Cumulated product			
				a [%]	e [%%]	r [%]	r [%]	a [%]	e [%%]	r [%]	r [%]	a [%]	e [%%]	a [%]	e [%%]
19 N	(-)	1808,2	20,64	1,82	37,63	3,57	98,18	2026,57	22,66	1,82	37,63	98,18	2026,57	22,66	
19 C	(o)	5470,8	62,45	7,02	438,42	41,56	92,98	5806,92	64,92	<b>5,73</b>	476,05	94,27	7833,50	<b>87,57</b>	
19 P	(+)	1480,8	16,90	<b>34,24</b>	578,86	<b>54,87</b>	65,76	1111,59	12,43	10,55	1054,91	89,45	8945,09	100,00	
19 F	Feed	8759,8	100,00	10,55	1054,91	100,00	89,45	8945,09	100,00	-	-	-	-	-	
		measured value:		10,12											

Sample Test	Marble Designation	Yield mass		Class											
				HCl-Insol.				Carbonate				Cumulated product			
				a [%]	e [%%]	r [%]	r [%]	a [%]	e [%%]	r [%]	r [%]	a [%]	e [%%]	a [%]	e [%%]
20 N	(-)	3934,3	42,62	1,15	49,02	4,86	98,85	4213,36	46,86	1,15	49,02	98,85	4213,36	46,86	
20 C	(o)	4494,4	48,69	7,30	355,45	35,25	92,70	4513,73	50,20	<b>4,43</b>	404,47	95,57	8727,09	<b>97,06</b>	
20 P	(+)	801,6	8,68	<b>69,54</b>	603,92	<b>59,89</b>	30,46	264,53	2,94	10,08	1008,38	89,92	8991,62	100,00	
20 F	Feed	9230,3	100,00	10,08	1008,38	100,00	89,92	8991,62	100,00	-	-	-	-	-	
		measured value:		10,18											

## Analysis of triboelectrostatic separation tests

Sample Test	Marble Designation	Yield mass		Class										
		[g]	[%]	HCl-Insol.			Carbonate			Cumulated product				
				a [%]	e [%%]	r [%]	a [%]	e [%%]	r [%]	a [%]	e [%%]	r [%]		
21 N	(-)	3785,5	41,00	1,07	43,87	4,33	98,93	4055,83	45,13	1,07	43,87	98,93	4055,83	45,13
21 C	(o)	4190,1	45,38	5,62	255,03	25,15	94,38	4282,85	47,66	<b>3,46</b>	298,90	96,54	8338,69	<b>92,80</b>
21 P	(+)	1258,0	13,62	<b>52,48</b>	715,00	<b>70,52</b>	47,52	647,42	7,20	10,14	1013,89	89,86	8986,11	100,00
21 F	Feed	9233,6	100,00	10,14	1013,89	100,00	89,86	8986,11	100,00	-	-	-	-	-
		measured value:		10,70										

Sample Test	Marble Designation	Yield mass		Class										
		[g]	[%]	HCl-Insol.			Carbonate			Cumulated product				
				a [%]	e [%%]	r [%]	a [%]	e [%%]	r [%]	a [%]	e [%%]	r [%]		
22 N	(-)	3819,6	41,41	1,10	45,55	4,48	98,90	4095,30	45,58	1,10	45,55	98,90	4095,30	45,58
22 C	(o)	4171,0	45,22	6,20	280,35	27,60	93,80	4241,45	47,21	<b>3,76</b>	325,90	96,24	8336,75	<b>92,79</b>
22 P	(+)	1233,6	13,37	<b>51,59</b>	689,94	<b>67,92</b>	48,41	647,41	7,21	10,16	1015,84	89,84	8984,16	100,00
22 F	Feed	9224,2	100,00	10,16	1015,84	100,00	89,84	8984,16	100,00	-	-	-	-	-
		measured value:		10,67										

## Analysis of triboelectrostatic separation tests

Sample Test	Marble 23	Yield mass		Class						Cumulated product							
		Designation		HCl-Insol.			Carbonate			Yield mass		HCl-Insol.			Carbonate		
		[g]	[%]	a [%]	e [%%]	r [%]	a [%]	e [%%]	r [%]	[%]	a [%]	e [%%]	a [%]	e [%%]	r [%]		
23 N	(-)	4077,0	44,15	1,26	55,63	5,64	98,74	4359,71	48,37	44,15	1,26	55,63	98,74	4359,71	48,37		
23 C	(o)	4198,9	45,47	6,48	294,67	29,87	93,52	4252,70	47,18	<b>89,63</b>	<b>3,91</b>	350,30	96,09	8612,41	<b>95,55</b>		
23 P	(+)	957,8	10,37	<b>61,34</b>	636,27	<b>64,49</b>	38,66	401,02	4,45	100,00	9,87	986,57	90,13	9013,43	100,00		
23 F	Feed	9233,7	100,00	9,87	986,57	100,00	90,13	9013,43	100,00	-	-	-	-	-	-		
		measured value:		9,95													

Sample Test	Marble 24	Yield mass		Class						Cumulated product							
		Designation		HCl-Insol.			Carbonate			Yield mass		HCl-Insol.			Carbonate		
		[g]	[%]	a [%]	e [%%]	r [%]	a [%]	e [%%]	r [%]	[%]	a [%]	e [%%]	a [%]	e [%%]	r [%]		
24 N	(-)	4294,1	46,69	1,12	52,30	5,25	98,88	4616,93	51,28	46,69	1,12	52,30	98,88	4616,93	51,28		
24 C	(o)	3908,5	42,50	6,61	280,92	28,19	93,39	3969,02	44,08	<b>89,19</b>	<b>3,74</b>	333,22	96,26	8585,95	<b>95,36</b>		
24 P	(+)	994,0	10,81	<b>61,36</b>	663,20	<b>66,56</b>	38,64	417,63	4,64	100,00	9,96	996,42	90,04	9003,58	100,00		
24 F	Feed	9196,6	100,00	9,96	996,42	100,00	90,04	9003,58	100,00	-	-	-	-	-	-		
		measured value:		10,33													

## Analysis of triboelectrostatic separation tests

Sample Test	Marble Designation	Yield mass		Class						Cumulated product						
		[g]	[%]	HCl-Insol.			Carbonate			Yield mass [%]	HCl-Insol.			Carbonate		
				a [%]	e [%%]	r [%]	a [%]	e [%%]	r [%]		a [%]	e [%%]	r [%]	a [%]	e [%%]	r [%]
25 N	(-)	4007,4	43,43	1,45	62,98	6,43	98,55	4280,24	47,45	43,43	1,45	62,98	98,55	4280,24	47,45	
25 C	(o)	4562,7	49,45	7,99	395,11	40,33	92,01	4549,94	50,44	<b>92,88</b>	<b>4,93</b>	<b>458,09</b>	95,07	8830,18	<b>97,89</b>	
25 P	(+)	656,7	7,12	<b>73,28</b>	521,56	<b>53,24</b>	26,72	190,17	2,11	100,00	9,80	979,64	90,20	9020,36	100,00	
25 F	Feed	9226,8	100,00	9,80	979,64	100,00	90,20	9020,36	100,00	-	-	-	-	-	-	
		measured value:		10,13												

Sample Test	Marble Designation	Yield mass		Class						Cumulated product						
		[g]	[%]	HCl-Insol.			Carbonate			Yield mass [%]	HCl-Insol.			Carbonate		
				a [%]	e [%%]	r [%]	a [%]	e [%%]	r [%]		a [%]	e [%%]	r [%]	a [%]	e [%%]	r [%]
26 N	(-)	2992,9	32,74	9,77	319,90	33,43	90,23	2954,39	32,67	32,74	9,77	319,90	90,23	2954,39	32,67	
26 C	(o)	2841,6	31,09	9,04	281,03	29,37	90,96	2827,73	31,27	<b>63,83</b>	<b>9,41</b>	<b>600,93</b>	90,59	5782,13	<b>63,94</b>	
26 P	(+)	3306,1	36,17	<b>9,84</b>	355,91	<b>37,20</b>	90,16	3261,03	36,06	100,00	9,57	956,84	90,43	9043,16	100,00	
26 F	Feed	9140,6	100,00	9,57	956,84	100,00	90,43	9043,16	100,00	-	-	-	-	-	-	
		measured value:		10,03												

## Analysis of triboelectrostatic separation tests

Sample Test	Marble Designation	Yield mass		Class						Cumulated product							
		[g]	[%]	HCl-Insol.			Carbonate			Yield mass [%]	HCl-Insol.			Carbonate			
				a [%]	e [%%]	r [%]	a [%]	e [%%]	r [%]		a [%]	e [%%]	r [%]	a [%]	e [%%]	r [%]	
27 N	(-)	2798,6	30,63	10,23	313,36	31,01	89,77	2749,77	30,59	30,63	10,23	313,36	89,77	2749,77	30,59		
27 C	(o)	3416,9	37,40	9,96	372,49	36,86	90,04	3367,38	37,46	<b>68,03</b>	<b>10,08</b>	685,85	89,92	6117,16	<b>68,05</b>		
27 P	(+)	2920,9	31,97	<b>10,16</b>	324,81	<b>32,14</b>	89,84	2872,18	31,95	100,00	10,11	1010,66	89,89	8989,34	100,00		
27 F	Feed	9136,4	100,00	10,11	1010,66	100,00	89,89	8989,34	100,00	-	-	-	-	-	-		
		measured value:		9,89													

Sample Test	Marble Designation	Yield mass		Class						Cumulated product							
		[g]	[%]	HCl-Insol.			Carbonate			Yield mass [%]	HCl-Insol.			Carbonate			
				a [%]	e [%%]	r [%]	a [%]	e [%%]	r [%]		a [%]	e [%%]	r [%]	a [%]	e [%%]	r [%]	
28 N	(-)	1939,8	21,06	3,97	83,61	8,62	96,03	2022,53	22,40	21,06	3,97	83,61	96,03	2022,53	22,40		
28 C	(o)	6405,3	69,55	8,42	585,57	60,38	91,58	6369,00	70,53	<b>90,61</b>	<b>7,39</b>	669,19	92,61	8391,53	<b>92,93</b>		
28 P	(+)	865,1	9,39	<b>32,00</b>	300,57	<b>30,99</b>	68,00	638,71	7,07	100,00	9,70	969,76	90,30	9030,24	100,00		
28 F	Feed	9210,2	100,00	9,70	969,76	100,00	90,30	9030,24	100,00	-	-	-	-	-	-		
		measured value:		9,92													

## Analysis of triboelectrostatic separation tests

Sample Test	Marble 29	Yield mass		Class						Cumulated product								
		Index	Designation	[g]	[%]	HCl-Insol.			Carbonate			Yield mass [%]	HCl-Insol.			Carbonate		
						a [%]	e [%%]	r [%]	a [%]	e [%%]	r [%]		a [%]	e [%%]	r [%]	a [%]	e [%%]	r [%]
29 N	(-)	3408,7	36,97	1,02	37,71	3,90	98,98	3659,40	40,51	36,97	1,02	37,71	3,90	98,98	3659,40	40,51		
29 C	(o)	4756,5	51,59	5,34	275,49	28,51	94,66	4883,46	54,06	<b>88,56</b>	<b>3,54</b>	313,20	96,46	8542,86	<b>94,57</b>			
29 P	(+)	1054,7	11,44	<b>57,08</b>	652,96	<b>67,58</b>	42,92	490,98	5,43	100,00	9,66	966,16	90,34	9033,84	100,00			
29 F	Feed	9219,9	100,00	9,66	966,16	100,00	90,34	9033,84	100,00	-	-	-	-	-	-			
		measured value:		10,04														

Sample Test	Marble 30	Yield mass		Class						Cumulated product								
		Index	Designation	[g]	[%]	HCl-Insol.			Carbonate			Yield mass [%]	HCl-Insol.			Carbonate		
						a [%]	e [%%]	r [%]	a [%]	e [%%]	r [%]		a [%]	e [%%]	r [%]	a [%]	e [%%]	r [%]
30 N	(-)	2346,7	25,67	10,07	258,54	26,02	89,93	2308,91	25,64	25,67	10,07	258,54	26,02	89,93	2308,91	25,64		
30 C	(o)	3738,7	40,90	9,11	372,63	37,51	90,89	3717,76	41,28	<b>66,58</b>	<b>9,48</b>	631,18	90,52	6026,66	<b>66,91</b>			
30 P	(+)	3054,8	33,42	<b>10,84</b>	362,29	<b>36,47</b>	89,16	2979,87	33,09	100,00	9,93	993,47	90,07	9006,53	100,00			
30 F	Feed	9140,2	100,00	9,93	993,47	100,00	90,07	9006,53	100,00	-	-	-	-	-	-			
		measured value:		9,75														



## Analysis of triboelectrostatic separation tests

Sample Test	Marble Designation	Yield mass		Class																	
				HCl-Insol.				Carbonate				Cumulated product									
				a [%]	e [%%]	r [%]	r [%]	a [%]	e [%%]	r [%]	r [%]	a [%]	e [%%]	a [%]	e [%%]	r [%]					
31 N	(-)	3518,0	39,06	9,82	383,53	39,75	90,18	3522,10	38,98	9,82	383,53	90,18	3522,10	38,98	39,06	9,82	383,53	90,18	3522,10	38,98	
31 C	(o)	2245,9	24,93	8,93	222,66	23,08	91,07	2270,71	25,13	<b>9,47</b>	606,19	90,53	5792,81	<b>64,11</b>	<b>63,99</b>	<b>9,47</b>	606,19	90,53	5792,81	<b>64,11</b>	
31 P	(+)	3243,6	36,01	<b>9,96</b>	358,66	<b>37,17</b>	90,04	3242,34	35,89	9,65	964,85	90,35	9035,15	100,00	100,00	9,65	964,85	90,35	9035,15	100,00	
31 F	Feed	9007,5	100,00	9,65	964,85	100,00	90,35	9035,15	100,00	-	-	-	-	-	-	-	-	-	-	-	
		measured value:		9,62																	

Sample Test	Marble Designation	Yield mass		Class																	
				HCl-Insol.				Carbonate				Cumulated product									
				a [%]	e [%%]	r [%]	r [%]	a [%]	e [%%]	r [%]	r [%]	a [%]	e [%%]	a [%]	e [%%]	r [%]					
32 N	(-)	4478,6	48,53	1,20	58,24	6,13	98,80	4794,72	52,98	1,20	58,24	98,80	4794,72	52,98	48,53	1,20	58,24	98,80	4794,72	52,98	
32 C	(o)	3716,2	40,27	5,65	227,52	23,94	94,35	3799,31	41,98	<b>3,22</b>	285,75	96,78	8594,04	<b>94,96</b>	<b>88,80</b>	<b>3,22</b>	285,75	96,78	8594,04	<b>94,96</b>	
32 P	(+)	1034,0	11,20	<b>59,32</b>	664,64	<b>69,93</b>	40,68	455,79	5,04	9,50	950,39	90,50	9049,83	100,00	100,00	9,50	950,39	90,50	9049,83	100,00	
32 F	Feed	9228,8	100,00	9,50	950,39	100,00	90,50	9049,83	100,00	-	-	-	-	-	-	-	-	-	-	-	
		measured value:		9,90																	

## Analysis of triboelectrostatic separation tests

Sample Test	Marble 33	Yield mass		Class						Cumulated product								
		[g]	[%]	HCl-Insol.		Carbonate		Yield mass [%]	HCl-Insol.		Carbonate							
				a [%]	e [%%]	r [%]	a [%]		e [%%]	r [%]	a [%]	e [%%]	r [%]					
Index	Designation																	
33 N	(-)	4150,0	45,10	1,36	61,34	6,18	98,64	4449,09	49,40	45,10	1,36	61,34	98,64	4449,09	49,40			
33 C	(o)	4081,4	44,36	6,78	300,75	30,28	93,22	4135,12	45,91	<b>89,46</b>	<b>4,05</b>	362,09	95,95	8584,20	<b>95,31</b>			
33 P	(+)	969,5	10,54	<b>59,91</b>	631,27	<b>63,55</b>	40,09	422,43	4,69	100,00	9,93	993,37	90,07	9006,63	100,00			
33 F	Feed	9200,9	100,00	9,93	993,37	100,00	90,07	9006,63	100,00	-	-	-	-	-	-			
		measured value:		9,67														

Sample Test	Marble 34	Yield mass		Class						Cumulated product								
		[g]	[%]	HCl-Insol.		Carbonate		Yield mass [%]	HCl-Insol.		Carbonate							
				a [%]	e [%%]	r [%]	a [%]		e [%%]	r [%]	a [%]	e [%%]	r [%]					
Index	Designation																	
34 N	(-)	4090,1	44,42	1,08	47,97	4,90	98,92	4393,69	48,70	44,42	1,08	47,97	98,92	4393,69	48,70			
34 C	(o)	4082,9	44,34	5,68	251,84	25,73	94,32	4182,00	46,36	<b>88,75</b>	<b>3,38</b>	299,81	96,62	8575,68	<b>95,06</b>			
34 P	(+)	1035,5	11,25	<b>60,39</b>	679,09	<b>69,37</b>	39,61	445,42	4,94	100,00	9,79	978,90	90,21	9021,10	100,00			
34 F	Feed	9208,5	100,00	9,79	978,90	100,00	90,21	9021,10	100,00	-	-	-	-	-	-			
		measured value:		10,10														



## Analysis of triboelectrostatic separation tests

Sample Test	Marble 37	Yield mass		Class						Cumulated product					
		Designation		HCl-Insol.			Carbonate			Yield mass		HCl-Insol.		Carbonate	
		[g]	[%]	a [%]	e [%%]	r [%]	a [%]	e [%%]	r [%]	[%]	a [%]	e [%%]	a [%]	e [%%]	r [%]
37 N	(-)	2498,6	27,13	0,78	21,16	2,17	99,22	2691,44	29,83	27,13	0,78	21,16	99,22	2691,44	29,83
37 C	(o)	5542,8	60,18	4,48	269,59	27,62	95,52	5747,94	63,70	<b>87,30</b>	<b>3,33</b>	290,74	96,67	8439,38	<b>93,52</b>
37 P	(+)	1169,7	12,70	<b>53,98</b>	685,48	<b>70,22</b>	46,02	584,40	6,48	100,00	9,76	976,22	90,24	9023,78	100,00
37 F	Feed	9211,1	100,00	9,76	976,22	100,00	90,24	9023,78	100,00	-	-	-	-	-	-
		measured value:		10,00											

Sample Test	Marble 38	Yield mass		Class						Cumulated product					
		Designation		HCl-Insol.			Carbonate			Yield mass		HCl-Insol.		Carbonate	
		[g]	[%]	a [%]	e [%%]	r [%]	a [%]	e [%%]	r [%]	[%]	a [%]	e [%%]	a [%]	e [%%]	r [%]
38 N	(-)	1505,8	16,34	1,26	20,59	2,08	98,74	1613,54	17,90	16,34	1,26	20,59	98,74	1613,54	17,90
38 C	(o)	6573,1	71,33	5,64	402,32	40,73	94,36	6730,96	74,69	<b>87,67</b>	<b>4,82</b>	422,91	95,18	8344,50	<b>92,59</b>
38 P	(+)	1135,8	12,33	<b>45,82</b>	564,78	<b>57,18</b>	54,18	667,82	7,41	100,00	9,88	987,68	90,12	9012,32	100,00
38 F	Feed	9214,7	100,00	9,88	987,68	100,00	90,12	9012,32	100,00	-	-	-	-	-	-
		measured value:		9,87											

## Analysis of triboelectrostatic separation tests

Sample Test	Marble Designation	Yield mass		Class											
				HCl-Insol.				Carbonate				Cumulated product			
				a [%]	e [%%]	r [%]	r [%]	a [%]	e [%%]	r [%]	r [%]	a [%]	e [%%]	a [%]	e [%%]
39 N	(-)	763,5	8,29	3,36	27,85	2,79	96,64	801,01	8,90	3,36	27,85	2,79	96,64	801,01	8,90
39 C	(o)	7466,1	81,05	7,73	626,53	62,78	92,27	7478,66	83,08	7,73	626,53	62,78	92,27	7478,66	83,08
39 P	(+)	981,9	10,66	<b>32,24</b>	343,66	<b>34,43</b>	67,76	722,29	8,02	9,98	998,04	9,98	90,02	9001,96	100,00
39 F	Feed	9211,5	100,00	9,98	998,04	100,00	90,02	9001,96	100,00	-	-	-	-	-	-
		measured value:		9,76											

Sample Test	Marble Designation	Yield mass		Class											
				HCl-Insol.				Carbonate				Cumulated product			
				a [%]	e [%%]	r [%]	r [%]	a [%]	e [%%]	r [%]	r [%]	a [%]	e [%%]	a [%]	e [%%]
40 N	(-)	894,6	9,71	4,21	40,89	4,19	95,79	930,29	10,31	4,21	40,89	4,19	95,79	930,29	10,31
40 C	(o)	7201,0	78,17	7,77	607,41	62,19	92,23	7209,99	79,90	7,77	607,41	62,19	92,23	7209,99	79,90
40 P	(+)	1115,9	12,11	<b>27,11</b>	328,42	<b>33,62</b>	72,89	883,00	9,79	9,77	976,71	9,77	90,23	9023,29	100,00
40 F	Feed	9211,5	100,00	9,77	976,71	100,00	90,23	9023,29	100,00	-	-	-	-	-	-
		measured value:		10,38											

## Analysis of triboelectrostatic separation tests

Sample Test Index	Marble Designation	Yield mass		Class						Cumulated product							
		[g]	[%]	HCl-Insol.			Carbonate			Yield mass [%]	HCl-Insol.			Carbonate			
				a [%]	e [%%]	r [%]	a [%]	e [%%]	r [%]		a [%]	e [%%]	r [%]	a [%]	e [%%]	r [%]	
41 N	(-)	2098,6	22,79	10,06	229,25	23,53	89,94	2049,58	22,71	22,79	10,06	229,25	23,53	89,94	2049,58	22,71	
41 C	(o)	3467,5	37,65	9,39	353,56	36,28	90,61	3411,74	37,80	<b>60,44</b>	<b>9,64</b>	<b>582,81</b>	<b>36,28</b>	<b>90,36</b>	<b>5461,32</b>	<b>60,51</b>	
41 P	(+)	3643,0	39,56	<b>9,90</b>	391,63	<b>40,19</b>	90,10	3564,24	39,49	100,00	9,74	974,44	39,49	90,26	9025,56	100,00	
41 F	Feed	9209,1	100,00	9,74	974,44	100,00	90,26	9025,56	100,00	-	-	-	-	-	-	-	
		measured value:		10,09													

Sample Test Index	Marble Designation	Yield mass		Class						Cumulated product							
		[g]	[%]	HCl-Insol.			Carbonate			Yield mass [%]	HCl-Insol.			Carbonate			
				a [%]	e [%%]	r [%]	a [%]	e [%%]	r [%]		a [%]	e [%%]	r [%]	a [%]	e [%%]	r [%]	
42 N	(-)	1329,7	14,44	8,65	124,94	12,51	91,35	1319,46	14,66	14,44	8,65	124,94	12,51	91,35	1319,46	14,66	
42 C	(o)	6777,4	73,62	8,92	656,69	65,77	91,08	6705,33	74,49	<b>88,06</b>	<b>8,88</b>	<b>781,63</b>	<b>65,77</b>	<b>91,12</b>	<b>8024,79</b>	<b>89,15</b>	
42 P	(+)	1098,8	11,94	<b>18,17</b>	216,87	<b>21,72</b>	81,83	976,71	10,85	100,00	9,99	998,51	10,85	90,01	9001,49	100,00	
42 F	Feed	9205,9	100,00	9,99	998,51	100,00	90,01	9001,49	100,00	-	-	-	-	-	-	-	
		measured value:		9,75													

## Analysis of triboelectrostatic separation tests

Sample Test	Marble Designation	Yield mass		Class						Cumulated product							
		[g]	[%]	HCl-Insol.			Carbonate			Yield mass [%]	HCl-Insol.			Carbonate			
				a [%]	e [%%]	r [%]	a [%]	e [%%]	r [%]		a [%]	e [%%]	r [%]	a [%]	e [%%]	r [%]	
43 N	(-)	1175,7	12,80	3,57	45,70	4,65	96,43	1234,53	13,69	12,80	3,57	45,70	4,65	96,43	1234,53	13,69	
43 C	(o)	7336,7	79,89	8,12	648,71	66,00	91,88	7340,30	81,40	<b>92,69</b>	<b>7,49</b>	694,41	7,49	92,51	8574,82	<b>95,10</b>	
43 P	(+)	671,1	7,31	<b>39,48</b>	288,51	<b>29,35</b>	60,52	442,26	4,90	100,00	9,83	982,92	9,83	90,17	9017,08	100,00	
43 F	Feed	9183,5	100,00	9,83	982,92	100,00	90,17	9017,08	100,00	-	-	-	-	-	-	-	
		measured value:		9,66													

Sample Test	Marble Designation	Yield mass		Class						Cumulated product							
		[g]	[%]	HCl-Insol.			Carbonate			Yield mass [%]	HCl-Insol.			Carbonate			
				a [%]	e [%%]	r [%]	a [%]	e [%%]	r [%]		a [%]	e [%%]	r [%]	a [%]	e [%%]	r [%]	
44 N	(-)	2223,5	24,14	1,55	37,41	3,90	98,45	2376,39	26,29	24,14	1,55	37,41	3,90	98,45	2376,39	26,29	
44 C	(o)	6200,1	67,31	6,50	437,50	45,60	93,50	6293,25	69,61	<b>91,45</b>	<b>5,19</b>	474,91	5,19	94,81	8669,64	<b>95,90</b>	
44 P	(+)	788,0	8,55	<b>56,65</b>	484,61	<b>50,51</b>	43,35	370,83	4,10	100,00	9,60	959,52	9,60	90,40	9040,48	100,00	
44 F	Feed	9211,6	100,00	9,60	959,52	100,00	90,40	9040,48	100,00	-	-	-	-	-	-	-	
		measured value:		9,69													

## Analysis of triboelectrostatic separation tests

Sample Test	Marble Designation	Yield mass		Class						Cumulated product						
		[g]	[%]	HCl-Insol.			Carbonate			Yield mass [%]	HCl-Insol.			Carbonate		
				a [%]	e [%%]	r [%]	a [%]	e [%%]	r [%]		a [%]	e [%%]	r [%]	a [%]	e [%%]	r [%]
45 N	(-)	3225,1	35,00	1,31	45,85	4,67	98,69	3454,44	38,30	35,00	1,31	45,85	98,69	3454,44	38,30	
45 C	(o)	5078,0	55,11	5,52	304,22	30,99	94,48	5207,07	57,74	<b>90,12</b>	<b>3,88</b>	350,08	96,12	8661,51	<b>96,04</b>	
45 P	(+)	910,7	9,88	<b>63,90</b>	631,59	<b>64,34</b>	36,10	356,82	3,96	100,00	9,82	981,67	90,18	9018,33	100,00	
45 F	Feed	9213,8	100,00	9,82	981,67	100,00	90,18	9018,33	100,00	-	-	-	-	-	-	
		measured value:		9,93												

Sample Test	Marble Designation	Yield mass		Class						Cumulated product						
		[g]	[%]	HCl-Insol.			Carbonate			Yield mass [%]	HCl-Insol.			Carbonate		
				a [%]	e [%%]	r [%]	a [%]	e [%%]	r [%]		a [%]	e [%%]	r [%]	a [%]	e [%%]	r [%]
46 N	(-)	2643,9	28,69	10,61	304,39	31,52	89,39	2564,55	28,39	28,69	10,61	304,39	89,39	2564,55	28,39	
46 C	(o)	3095,3	33,59	8,17	274,41	28,41	91,83	3084,35	34,14	<b>62,28</b>	<b>9,29</b>	578,81	90,71	5648,90	<b>62,53</b>	
46 P	(+)	3476,4	37,72	<b>10,26</b>	387,04	<b>40,07</b>	89,74	3385,26	37,47	100,00	9,66	965,84	90,34	9034,16	100,00	
46 F	Feed	9215,6	100,00	9,66	965,84	100,00	90,34	9034,16	100,00	-	-	-	-	-	-	
		measured value:		10,81												



## Analysis of triboelectrostatic separation tests

Sample Test	Marble 47	Yield mass		Class						Cumulated product						
		[g]	[%]	HCl-Insol.			Carbonate			Yield mass [%]	HCl-Insol.			Carbonate		
				a [%]	e [%%]	r [%]	a [%]	e [%%]	r [%]		a [%]	e [%%]	r [%]	a [%]	e [%%]	r [%]
47 N	(-)	5298,3	26,89	1,00	26,89	2,63	99,00	2662,03	29,65	26,89	1,00	26,89	99,00	2662,03	29,65	
47 C	(o)	12146,0	61,64	5,72	352,59	34,48	94,28	5811,58	64,74	<b>88,53</b>	<b>4,29</b>	379,48	95,71	8473,61	<b>94,39</b>	
47 P	(+)	2259,9	11,47	<b>56,08</b>	643,19	<b>62,89</b>	43,92	503,72	5,61	100,00	10,23	1022,67	89,77	8977,33	100,00	
47 F	Feed	19704,2	100,00	10,23	1022,67	100,00	89,77	8977,33	100,00	-	-	-	-	-	-	
		measured value:		10,38												

Sample Test	Marble 47-1	Yield mass		Class						Cumulated product						
		[g]	[%]	HCl-Insol.			Carbonate			Yield mass [%]	HCl-Insol.			Carbonate		
				a [%]	e [%%]	r [%]	a [%]	e [%%]	r [%]		a [%]	e [%%]	r [%]	a [%]	e [%%]	r [%]
47 NN	(-)	244,6	5,04	0,54	2,72	2,72	99,46	501,34	5,06	5,04	0,54	2,72	99,46	501,34	5,06	
47 NC	(o)	4305,0	88,72	0,64	56,78	56,69	99,36	8814,75	89,04	<b>93,76</b>	<b>0,63</b>	59,50	99,37	9316,09	<b>94,10</b>	
47 NP	(+)	303,0	6,24	<b>6,51</b>	40,65	<b>40,59</b>	93,49	583,76	5,90	100,00	1,00	100,15	99,00	9899,85	100,00	
47 NF	Feed	4852,6	100,00	1,00	100,15	100,00	99,00	9899,85	100,00	-	-	-	-	-	-	
		measured value:		1,00												

## Analysis of triboelectrostatic separation tests

Sample Test	Marble 47-2	Yield mass		Class						Cumulated product							
		Yield mass		HCl-Insol.			Carbonate			Yield mass		HCl-Insol.			Carbonate		
		[g]	[%]	a [%]	e [%%]	r [%]	a [%]	e [%%]	r [%]	[%]	a [%]	e [%%]	a [%]	e [%%]	r [%]		
47 CN	(-)	2188,0	19,41	0,62	12,04	2,10	99,38	1929,23	20,46	19,41	0,62	12,04	99,38	1929,23	20,46		
47 CC	(o)	8015,4	71,12	2,42	172,10	30,09	97,58	6939,43	73,60	<b>90,53</b>	<b>2,03</b>	184,13	97,97	8868,66	<b>94,07</b>		
47 CP	(+)	1067,6	9,47	<b>40,94</b>	387,79	<b>67,80</b>	59,06	559,42	5,93	100,00	5,72	571,92	94,28	9428,08	100,00		
47 CF	Feed	11271,0	100,00	5,72	571,92	100,00	94,28	9428,08	100,00	-	-	-	-	-	-		
		measured value:		5,72													

Sample Test	Marble 47-3	Yield mass		Class						Cumulated product							
		Yield mass		HCl-Insol.			Carbonate			Yield mass		HCl-Insol.			Carbonate		
		[g]	[%]	a [%]	e [%%]	r [%]	a [%]	e [%%]	r [%]	[%]	a [%]	e [%%]	a [%]	e [%%]	r [%]		
47 PN	(-)	538,2	27,94	17,96	501,74	8,95	82,04	2291,92	52,19	27,94	17,96	501,74	82,04	2291,92	52,19		
47 PC	(o)	759,8	39,44	57,60	2271,71	40,51	42,40	1672,23	38,08	<b>67,38</b>	<b>41,16</b>	2773,45	58,84	3964,16	<b>90,26</b>		
47 PP	(+)	628,5	32,62	<b>86,89</b>	2834,69	<b>50,55</b>	13,11	427,70	9,74	100,00	56,08	5608,15	43,92	4391,85	100,00		
47 PF	Feed	1926,5	100,00	56,08	5608,15	100,00	43,92	4391,85	100,00	-	-	-	-	-	-		
		measured value:		56,08													